

KeyTec
České Budějovice

Our mission

Our KeyTec group provide Metal and Plastic parts and combine them in Mechatronic Manufacturing Solutions (MMS) for various application areas.

We are a reliable partner during the product life cycle for customers with a focus on technology and innovation.

“We Industrialize Your Idea”



Our company strategy

- Engineering & Manufacturing
- Metal & Plastic technologies
- Creating integrated modules/ products
- Worldwide production facilities
- One roof concept
- Joint focus on worldwide customer support
- Reliability and Trust

“Powerful in Metal-Plastic combinations”

Worldwide production

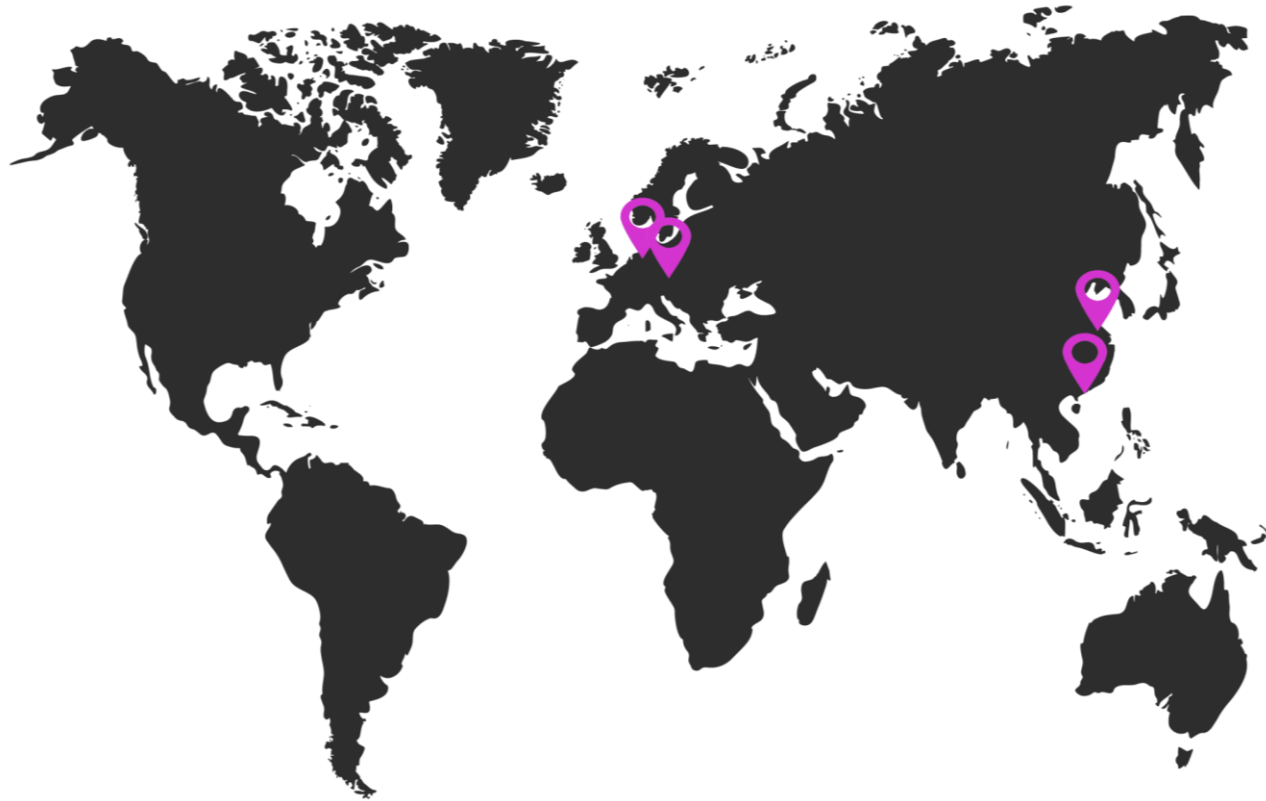

1. Netherlands

Eindhoven headquarters

Sittard

Proto & Mass production
Metal, Plastic and Assembly



2. Czech Republic

České Budějovice

Metal and Assembly



3. China

Suzhou PC

Metal, Plastic, Painting, Decoration
and Tooling

Suzhou MM

Assembly

Hongkong Rep. office

Our technologies

Metal

- Deep drawing
- Progression/
modular stamping
- Bihler bending
- Exotic metals

Plastic

- High volume
- Small series
- Reel to reel
- Insert molding
- 1K - 2K molding
- Engineering plastics

Assembly

- Laser welding
- Ultrasonic welding
- Electric welding
- Glueing
- Clinching

Decoration

- Painting
- Screen printing
- Laser etching
- Tampon printing
- Vacuum metalizing

Tools





KeyTec group

Our customers

- Multinational
- Worldwide focus
- Pro active
- Zero-defect Quality



“Powerful in Metal-Plastic combinations”

Quality in KeyTec group

KeyTec plant	ISO 9001 Quality system	ISO 14000 Enviroment	IATF 16949 Automotive	ISO 13485 Medical	SA 8000, EICC Social Acc.	ISO 22030 Continuity
Sittard, Netherlands	Certified	Certified	Certified	Compliant EU-MDR	Certified	Certified
Ceské Budejovice, Czech Republic	Certified	Certified	Certified	Not applicable	Certified	Certified
Suzhou, China	Certified	Certified	Certified	Certified	Certified	Certified



Certified



Compliant



Not applicable

KeyTec Ceske Budejovice

LOCATION



KeyTec
PRECISION COMPONENTS

Novohradská 1764
370 01 České Budějovice
keytec@keytec.cz
www.keytec.cz
+420 389 002 111
CZECH REPUBLIC

GENERAL INFO

- Established in 1994
- 300 colleagues
- 22 000 m2 floorspace
- Annual revenues more than 25 mil. EUR

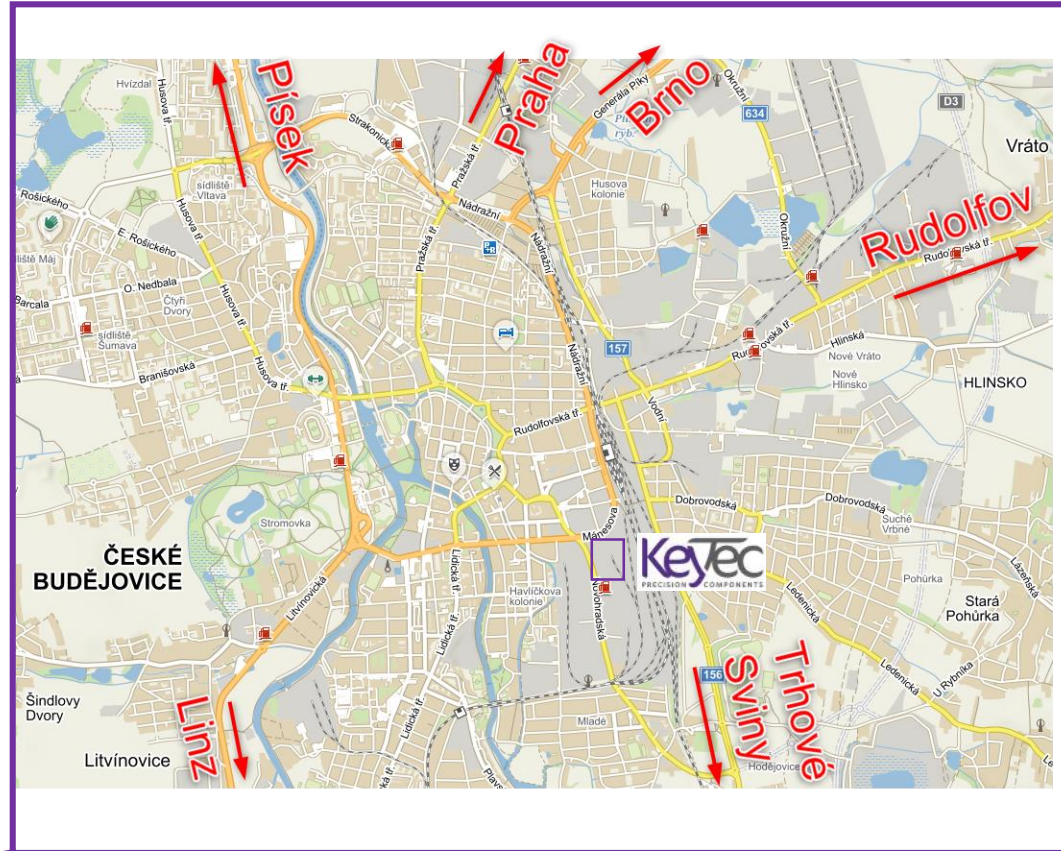
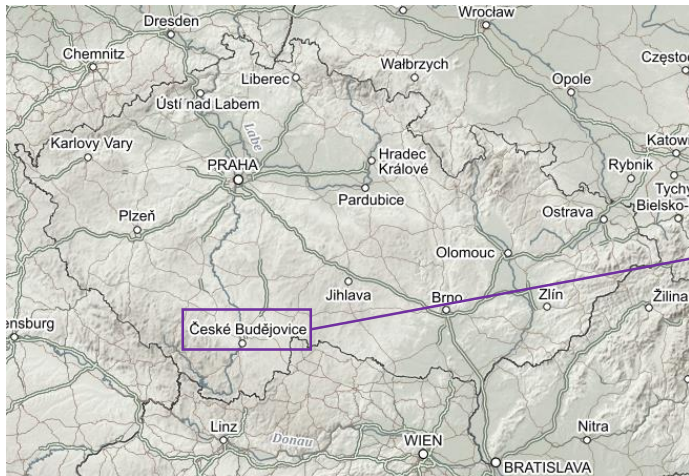

MAIN TECHNOLOGY

Progressive metal stamping



Aida 630 t



EBU 630 t

14 press lines:

- 32 - 630 tons (servo and eccentric presses)
- Max tool dimensions 4000x1500 mm
- Kaiser, Müller, Beutler Nova, Aida, EBU Burkhardt
- Thickness 0,3 – 8 mm
- Processing of hightensile steel

MAIN TECHNOLOGY

Metal stamping

Transfer line

- 6 x Aida 200 tons 1390 x 840 mm



Transfer line

26 individual presses:

- 63 - 250 tons
- Max tool dimensions 1250 x 750 mm
- Müller, Aida, Beutler Nova



Aida 250 t

OTHER TECHNOLOGY

Threadcutting (M2-M10)

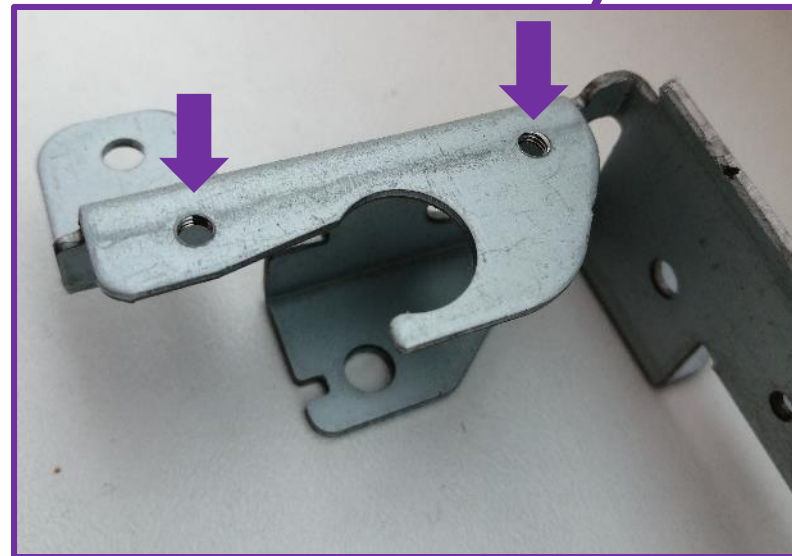

OTHER TECHNOLOGY

Projection welding (nut welding)

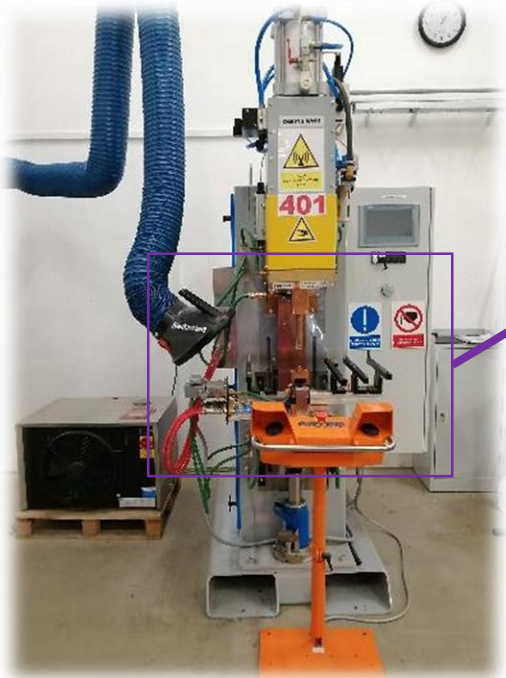

OTHER TECHNOLOGY

Press nut assembly (replacement of welding)

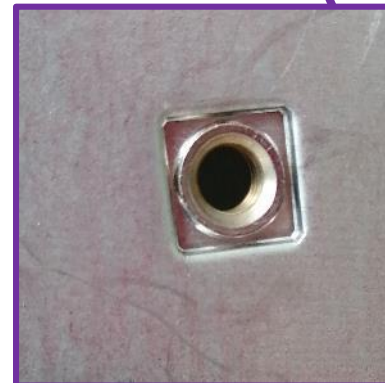
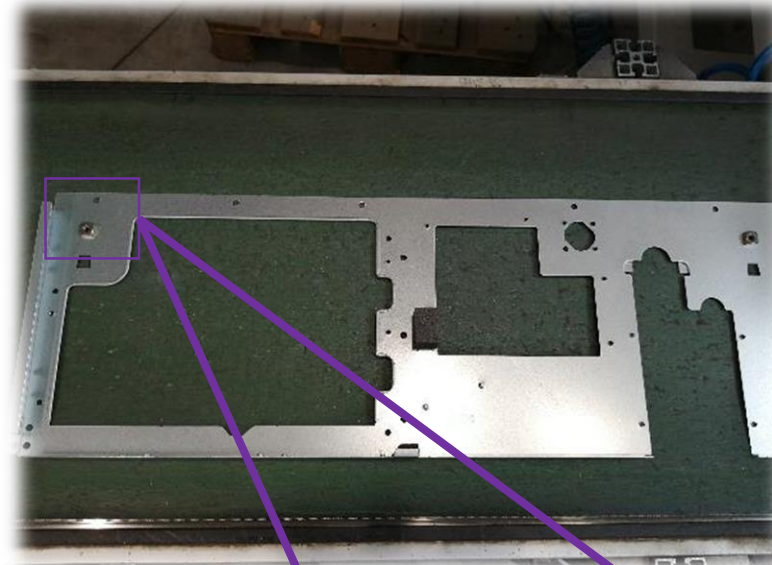
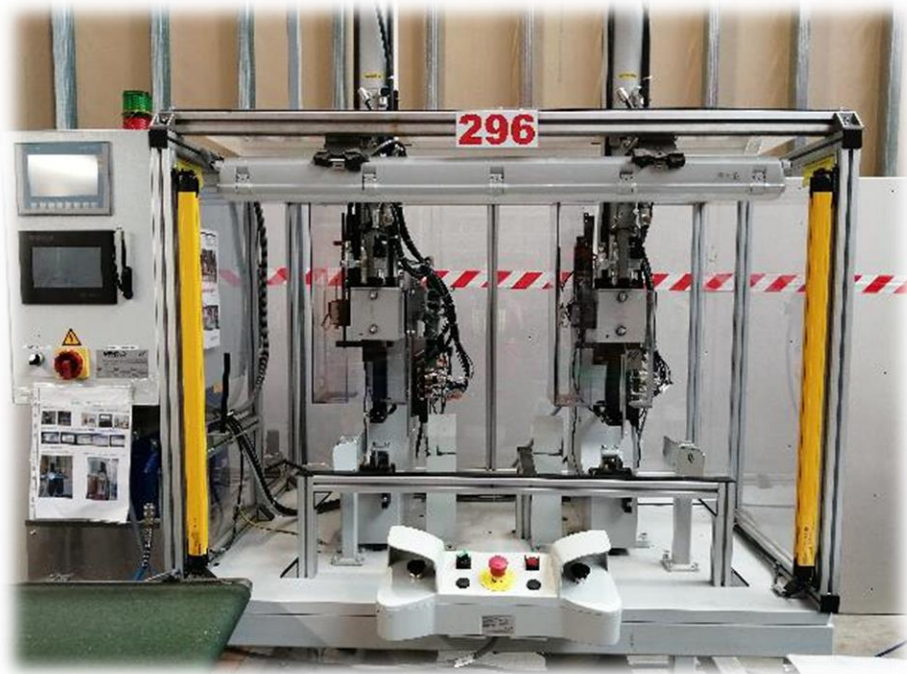

OTHER TECHNOLOGY

Laser marking (QR)

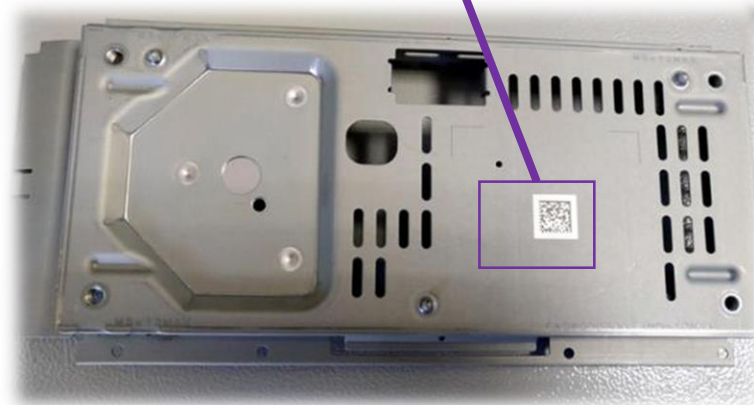

OTHER TECHNOLOGY

Degreasing



And others...

- Riveting
- Toxing
- Assembly
- Deburring

CONSTRUCTION DEPARTMENT

- Our own construction office using following software:

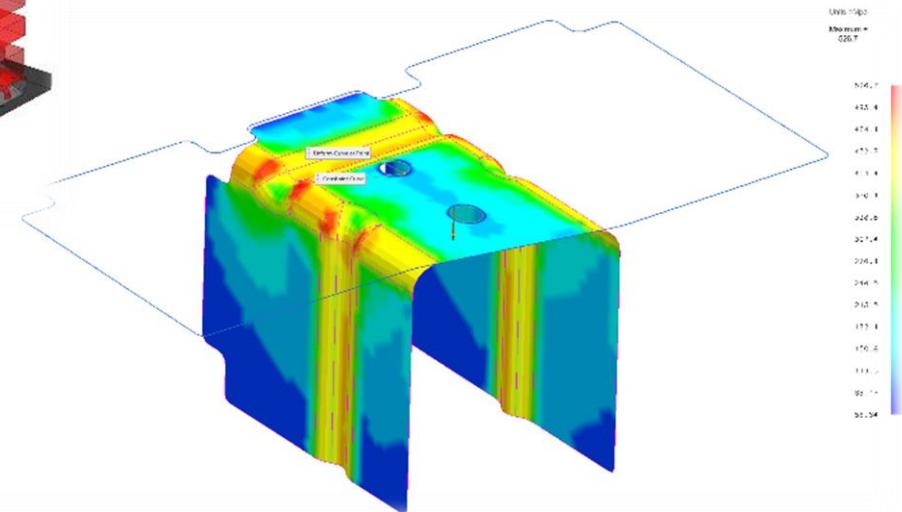
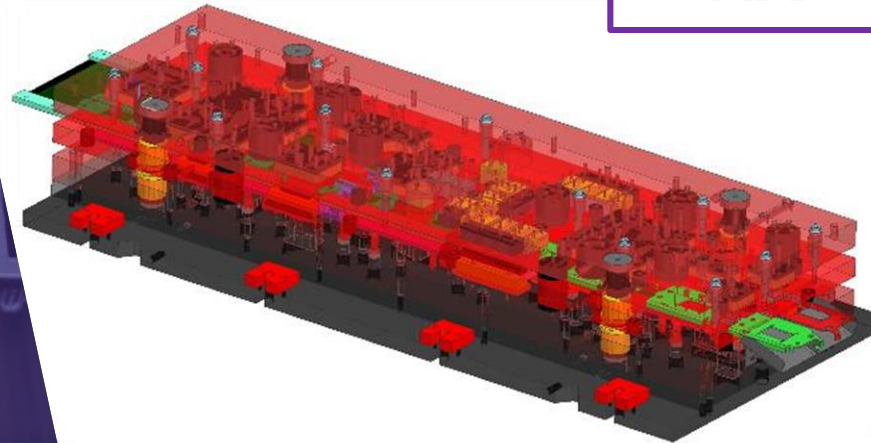

TOOL SHOP

- Our own tool shop, who maintains and repairs over 1000 tools



MEASURING EQUIPMENT

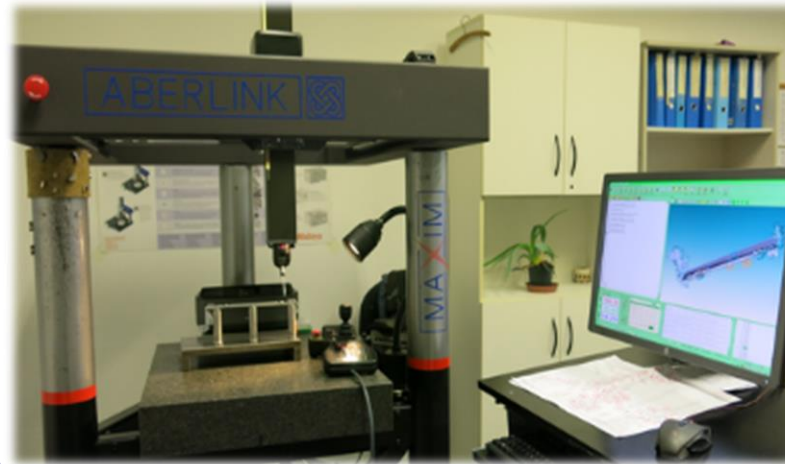

3D CNC ABERLINK MAXIM
Range of measurement 600x500x400 mm
SW Renishaw MODUS

3D CNC EQUATOR Renishaw
Range of measurement 300x300x150 mm
SW Renishaw MODUS



CP004	Skupina	Jmen	Rezol	M. kol	D. kol	Chyba
Průměr	16.76	16.00	0.15	0.20	-0.10	0.00
Im. pol. 2D	0.28	0.00	0.08	0.00	+ 0.00	

CP003	Skupina	Jmen	Rezol	M. kol	D. kol	Chyba
Průměr	16.76	16.00	0.15	0.20	-0.10	0.00
Im. pol. 2D	0.12	0.00	0.12	0.00	+ 0.00	

CP002	Skupina	Jmen	Rezol	M. kol	D. kol	Chyba
Průměr	8.08	8.00	0.08	0.20	0.10	0.00
Im. pol. 2D	0.08	0.00	0.08	0.00	+ 0.00	

CP001	Skupina	Jmen	Rezol	M. kol	D. kol	Chyba
Průměr	5.06	5.00	0.06	0.20	-0.00	0.00
Im. pol. 2D	0.00	0.00	0.00	0.00	+ 0.00	

EL1001	Skupina	Jmen	Rezol	M. kol	D. kol	Chyba
Velik.	20.28	20.00	0.28	0.40	-0.10	0.00
U. kol	8.30	8.00	0.10	0.00	-0.10	0.00

CP001	Skupina	Jmen	Rezol	M. kol	S. kol	Chyba
Průměr	18.18	18.00	0.18	0.20	-0.10	0.00



MEASURING EQUIPMENT

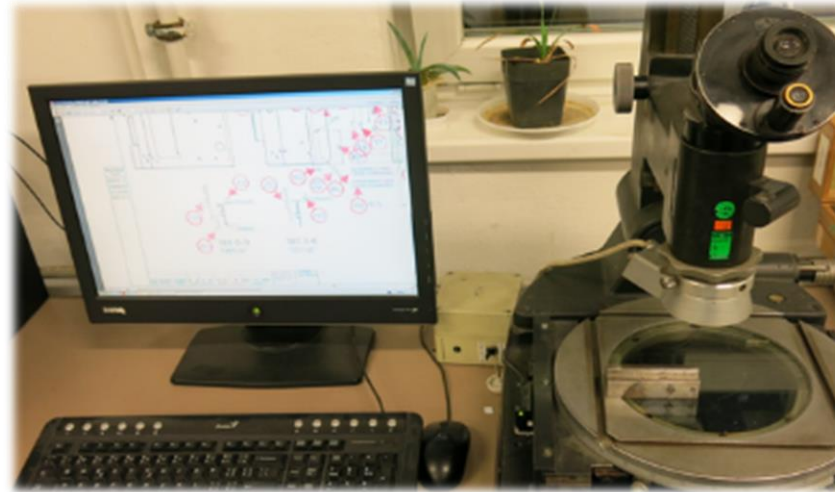

Mikroskope Carl Zeiss
Range of measurement 100x50 mm
SW TANGO



Vertex 310
Optical 3D measurement

CERTIFICATION

IATF 16949:2016

ISO 9001:2015

ISO 14001:2015

 **Lloyd's Register**

Certification date: 16 June 2021
Expiry date: 16 June 2024
Certificate number: 1268364
IATF Certificate number: 0662206

Certificate of Approval

This is to certify that the Management System of:
KeyTec České Budějovice s.r.o.
Novohradská 1764, 370 01 České Budějovice 6, Czech Republic

has been approved by Lloyd's Register to the following standards:
IATF 16949:2016 (excluding product design)
Approval number(s): IATF 16949 – 00012592-001

The scope of this approval is applicable to:
Production and assembly of stamped metal parts.

Paul Graaf
Chief Operating Officer, Management Systems, M&S
Issued by: Lloyd's Register Quality Assurance Limited



Lloyd's Register Group Limited, its affiliates and subsidiaries, including Lloyd's Register Quality Assurance Limited (LRQA), and their respective officers, employees or agents are, individually and collectively, referred to in this clause as 'Lloyd's Register'. Lloyd's Register assumes no responsibility and shall not be liable to any person for any loss, damage or expense caused by reliance on the information or advice in this document or for any other reason, unless that person has agreed a contract with the relevant Lloyd's Register entity for the provision of this information or advice and in that case any responsibility or liability is exclusively on the terms and conditions set out in that contract. Issued by: Lloyd's Register Quality Assurance Limited, 1 Trinity Park, Sickenhall Lane, Birmingham B37 7YD, United Kingdom.

Page 1 of 1

CERTIFICATE
No. 42013339

This is to certify the Quality Management System of

KeyTec České Budějovice s.r.o.
Novohradská 1764
370 21 Ceske Budejovice, Ceske Budejovice 6
Czech Republic

has been assessed and found to be in compliance with the Standard
ISO 9001:2015
applicable to:
Production and assembly of stamped metal parts for automotive, electrical and ICT industry.

The certificate has been issued under No. 42013339 for the registration period from 05 February 2020 to 04 February 2023.
The first certificate date of issue is 01 February 2014.

 
Approved by: _____ Printed by: _____

validity code **B922F97E-158**
Check the validity of this certificate using this code at www.ll-c.info
LL-C (Certification) Czech Republic a.s. | Pobožni 620/3, 186 00 Praha 8

CERTIFICATE
No. 42013339

This is to certify the Environmental Management System of

KeyTec České Budějovice s.r.o.
Novohradská 1764
370 21 Ceske Budejovice, Ceske Budejovice 6
Czech Republic

has been assessed and found to be in compliance with the Standard
ISO 14001:2015
applicable to:
Production and assembly of stamped metal parts for automotive, electrical and ICT industry.

The certificate has been issued under No. 42013339 for the registration period from 05 February 2020 to 04 February 2023.
The first certificate date of issue is 01 February 2014.

 
Approved by: _____ Printed by: _____

validity code **AA6541F1-D9F**
Check the validity of this certificate using this code at www.ll-c.info
LL-C (Certification) Czech Republic a.s. | Pobožni 620/3, 186 00 Praha 8

USAGE OF OUR PRODUCTS

Bumpers Nissan Juke

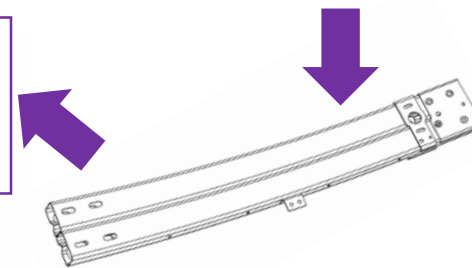
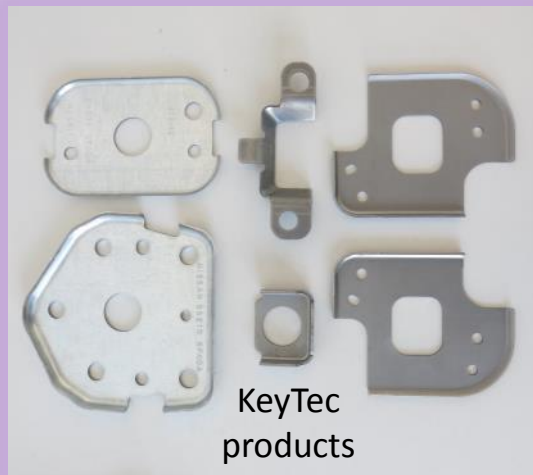
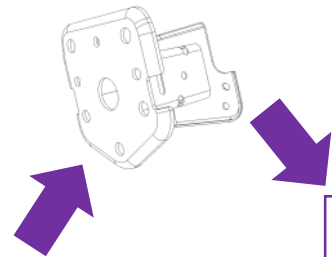

USAGE OF OUR PRODUCTS

Bumper Renault Espace



USAGE OF OUR PRODUCTS

Bumpers Nissan Micra

KeyTec products

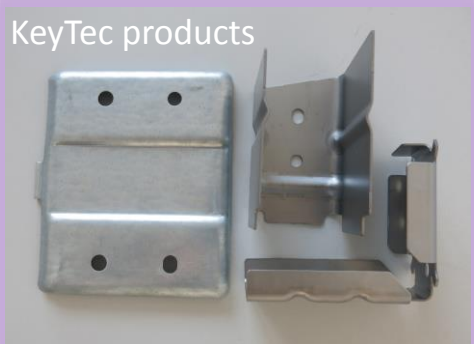

KeyTec products



KeyTec products

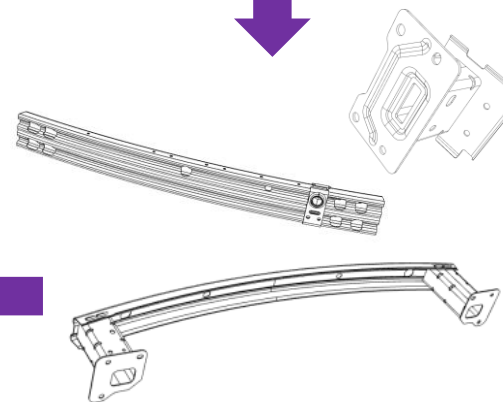
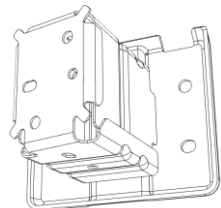

USAGE OF OUR PRODUCTS

Seats rails VW Amarok

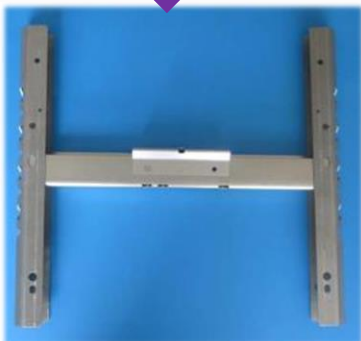

USAGE OF OUR PRODUCTS

Infotainment Mercedes M, GL, SLK, CLS, A, B

KeyTec product

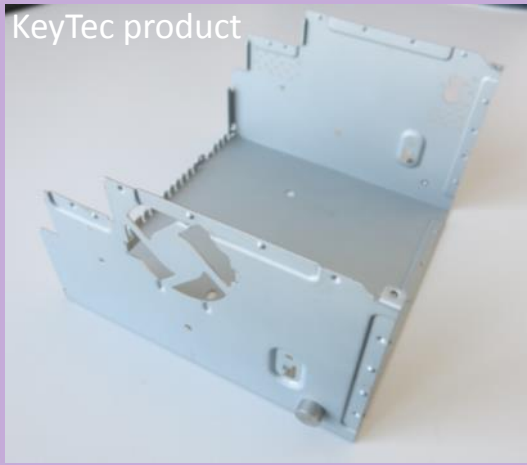

USAGE OF OUR PRODUCTS

Infotainment Audi A1 / Q3

KeyTec product

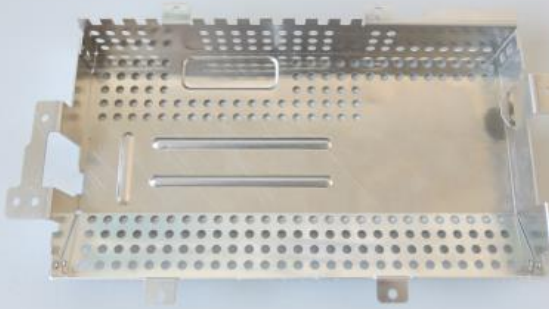

Q3

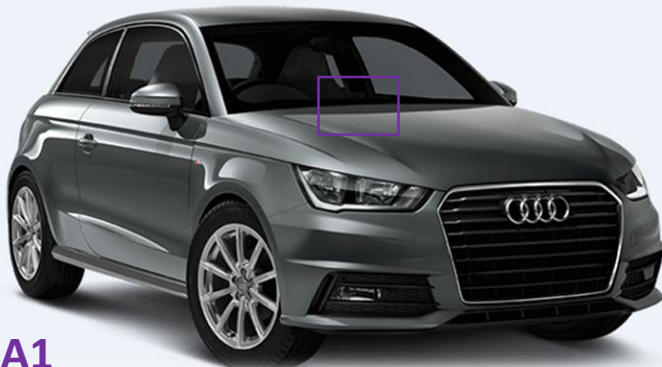

A1

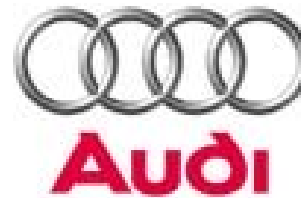

USAGE OF OUR PRODUCTS

Infotainment Range Rover Velar

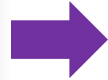
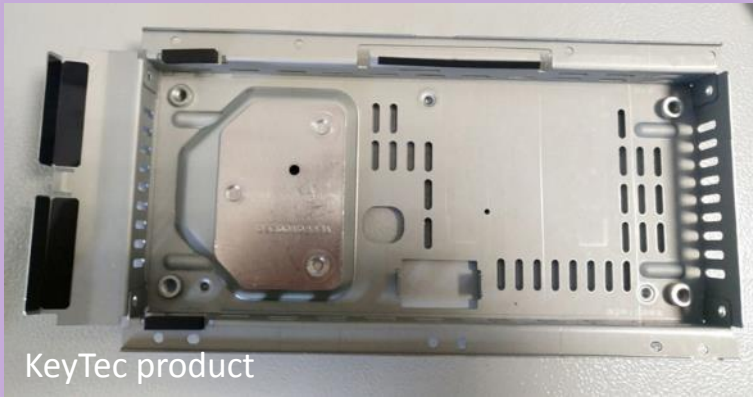

USAGE OF OUR PRODUCTS

Infotainment VW Golf

KeyTec products

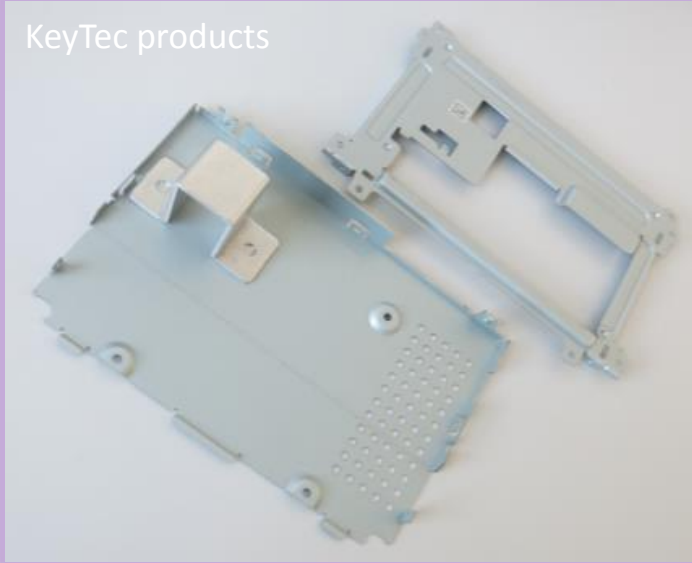

USAGE OF OUR PRODUCTS

Aircondition components Daikin

KeyTec products

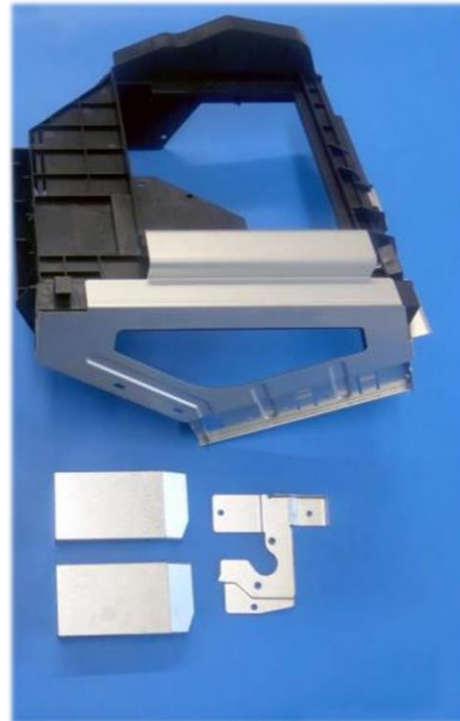
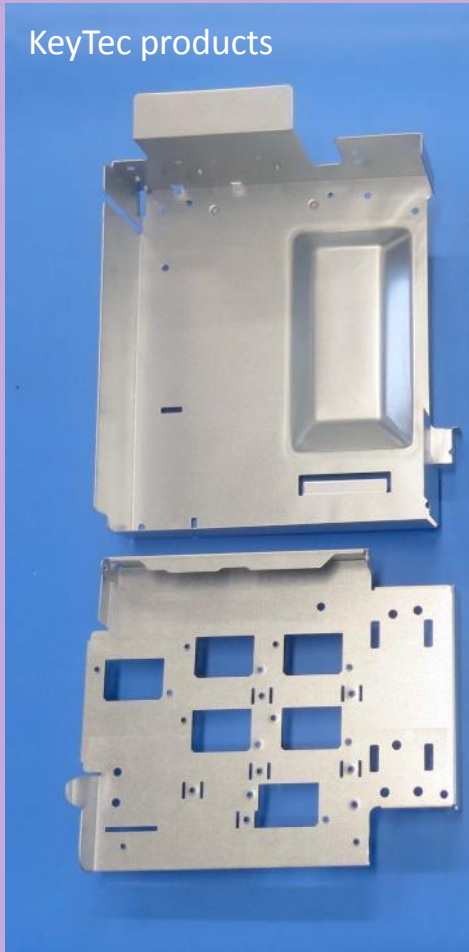

USAGE OF OUR PRODUCTS

Aircondition components Daikin

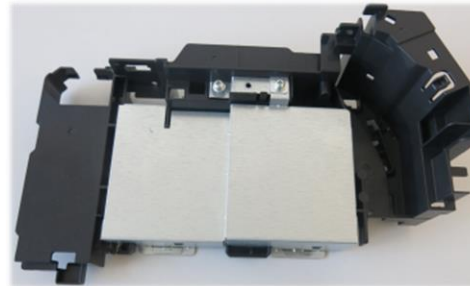

USAGE OF OUR PRODUCTS

Aircondition components Daikin (indoor unit)

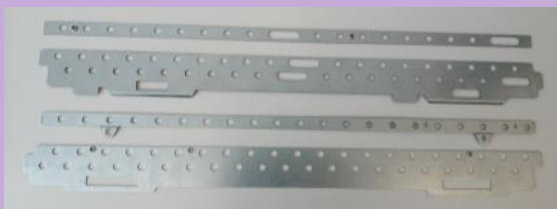
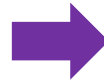

USAGE OF OUR PRODUCTS

Heat pump components Daikin



USAGE OF OUR PRODUCTS

Heat pump components Daikin

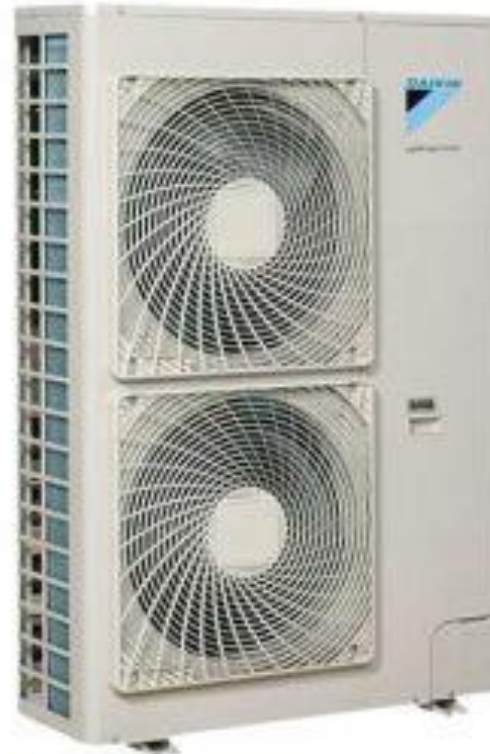
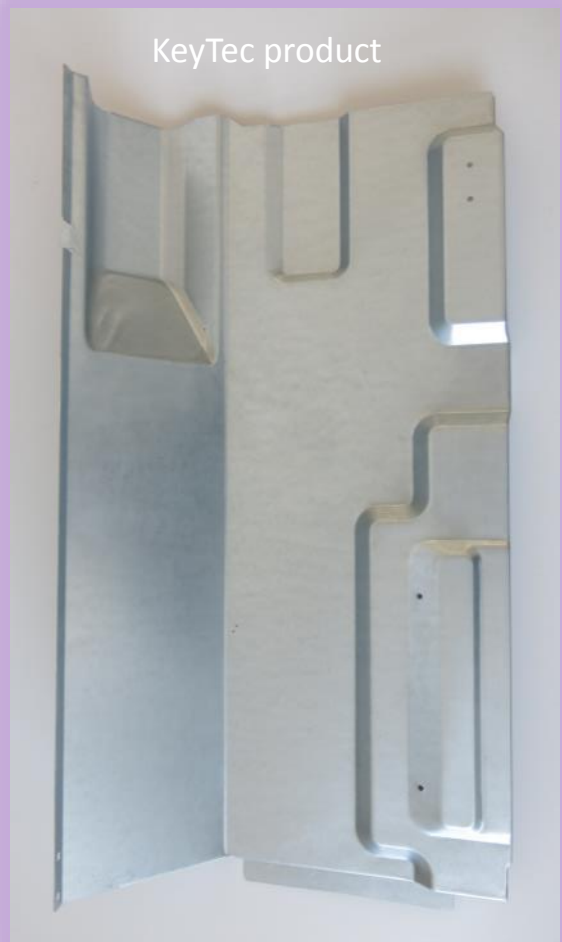

USAGE OF OUR PRODUCTS

Heat pump components Daikin

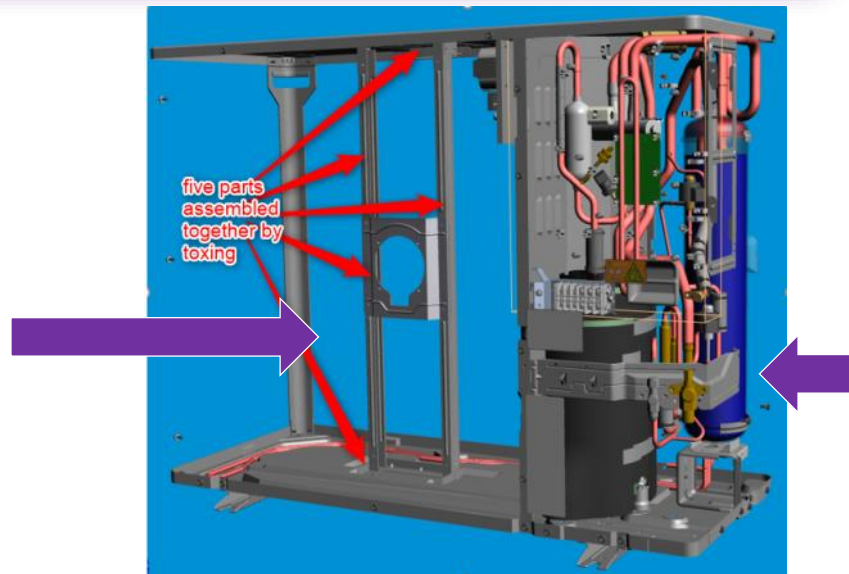
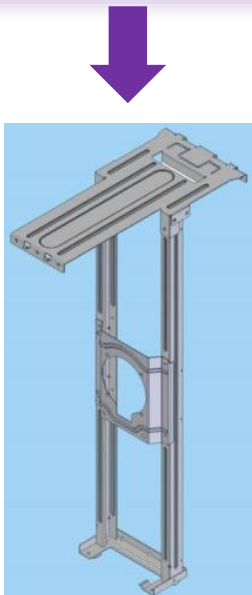

USAGE OF OUR PRODUCTS

Lighting components Signify (Philips)

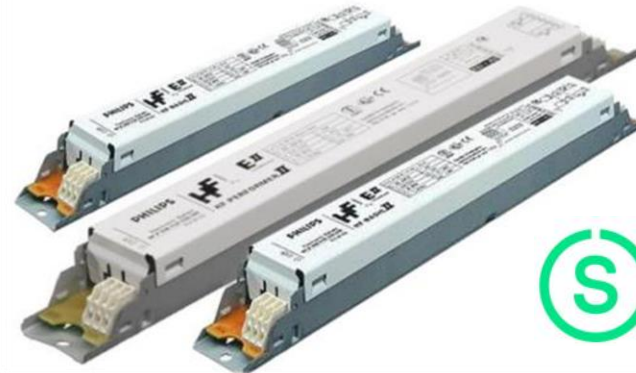
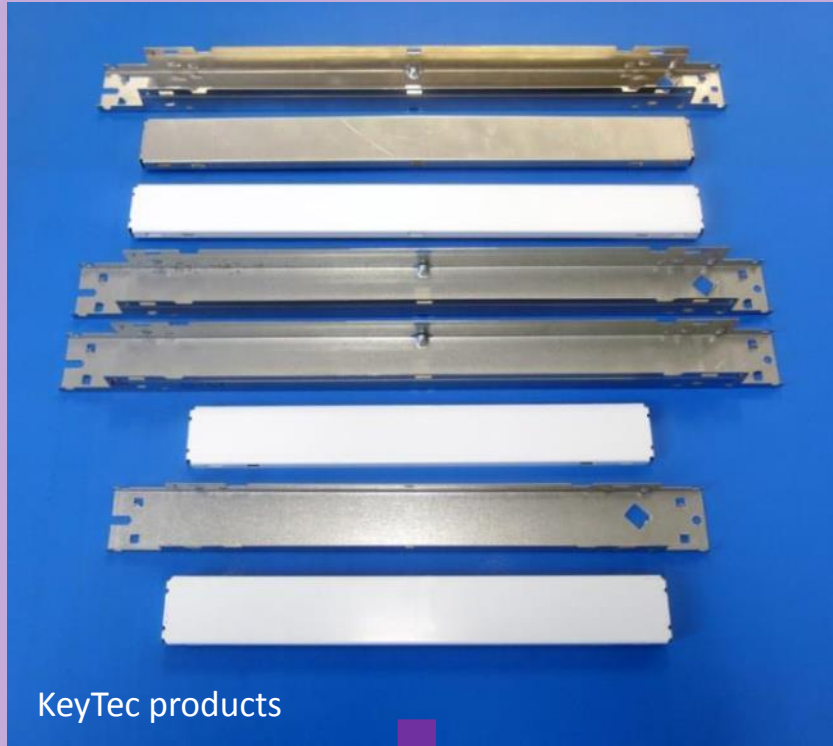

Signify

USAGE OF OUR PRODUCTS

Control unit for greenhouse heating / lighting

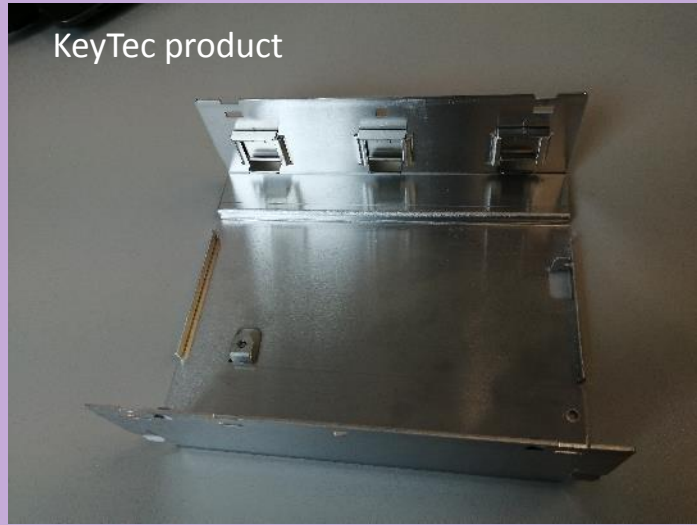

Signify

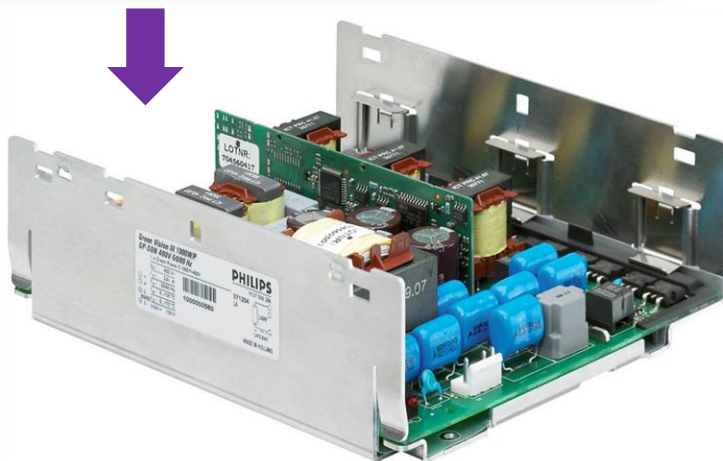

USAGE OF OUR PRODUCTS

Traffic lights components Swarco

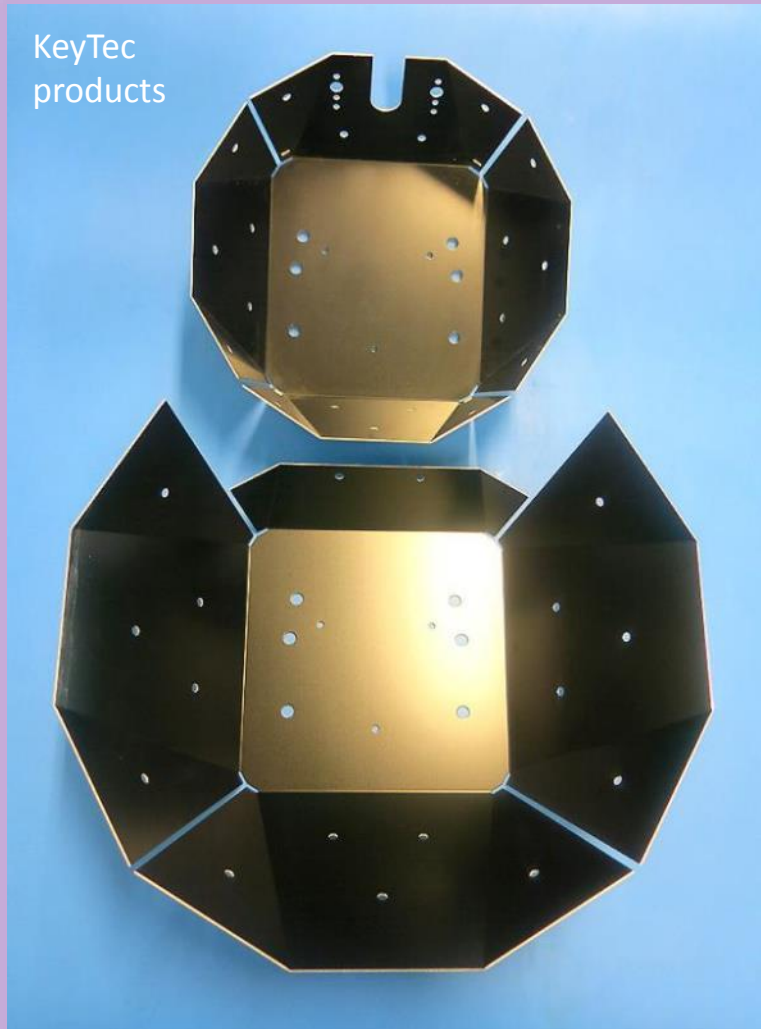



“We Industrialize Your Idea”

www.KeyTecGroup.com

