

KeyTec
České Budějovice

Naše mise

KeyTec vyrábí kovové součástky a jejich kombinace v řešeních mechatronické výroby (MMS) pro různé oblasti použití.

Jsme spolehlivým partnerem během životního cyklu produktu pro zákazníky se zaměřením na technologie a inovace.

“We Industrialize Your Idea”



Naše firemní strategie

- Strojírenství a výroba
- Kovové technologie
- Vytváření integrovaných modulů/produktů
- Koncept One Roof
- Spolehlivost a důvěra

“Powerful in Metal combinations”

KeyTec České Budějovice

KeyTEC
PRECISION COMPONENTS



Novohradská 1764
370 01 České Budějovice
keytec@keytec.cz
www.keytec.cz
+420 389 002 111
CZECH REPUBLIC

Hlavní technologie

Postupové lisování plechu za studena



Aida 630 t



EBU 630 t

19 automatických linek:

- 160 - 630 tun (servo a excentrické lisy)
- Lisovací stůl až 4000x1500 mm
- Kaiser, Müller, Beutler Nova, Aida, EBU Burkhardt
- Tloušťka 0,3 – 8 mm
- Zpracování vysokopevnostní oceli

Hlavní technologie

Lisování plechu za studena

Robotická tandemová linka

- 5 x SIMPAC 200 tun 1500 x 900 mm
- 7 x KUKA KR IONTEC 50
- Mazací a centrovací stůl SAGOMA 1000

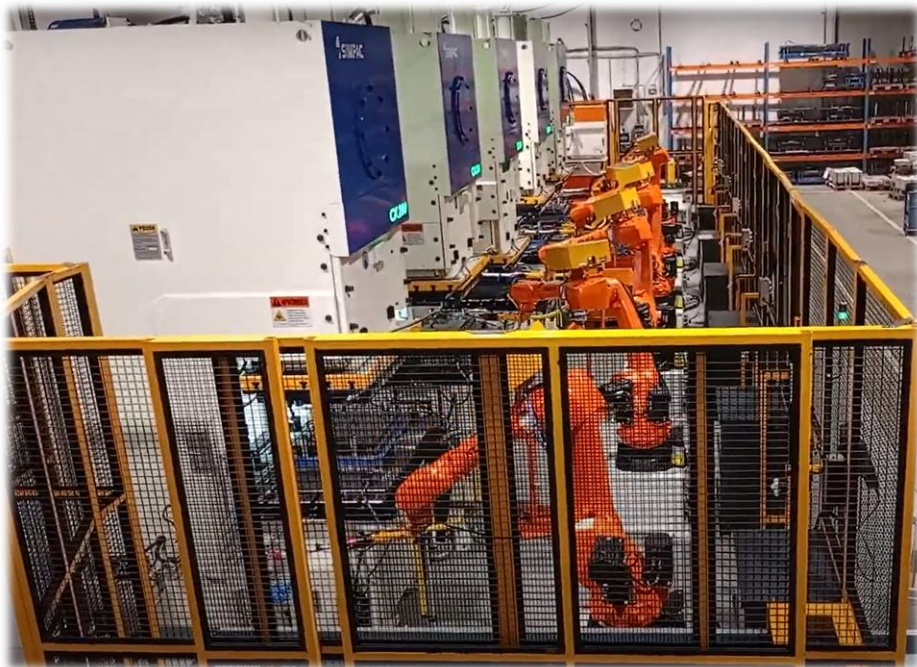

Hlavní technologie

Lisování plechu za studena

Transferová linka

- 6 x Aida 200 tun 1390 x 840 mm



Transferová linka

26 samostatných lisů:

- 100 - 250 tons
- Lisovací stůl 1250 x 750 mm
- Müller, Aida, Beutler Nova



Aida 250 t

Ostatní technologie

Řezání závitů (M2-M10)

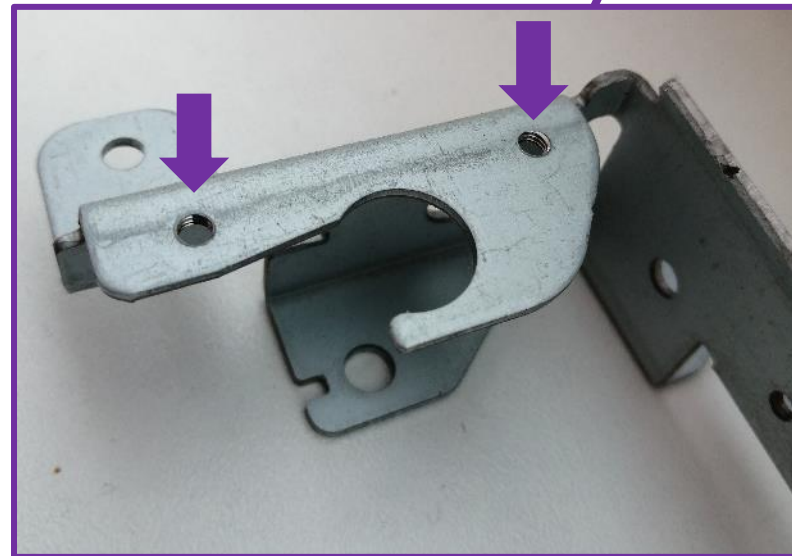

Ostatní technologie

Odporové navařování matek

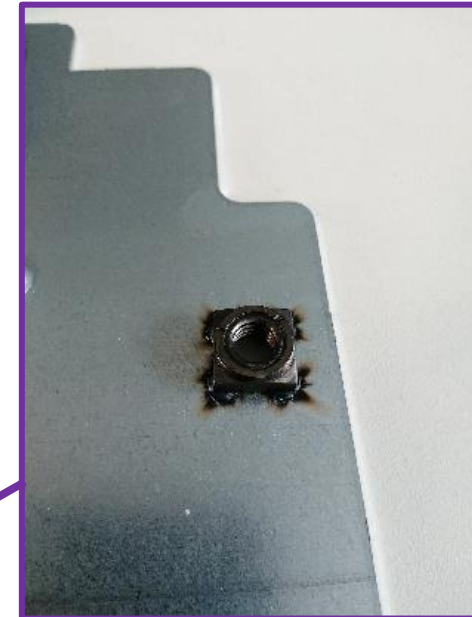
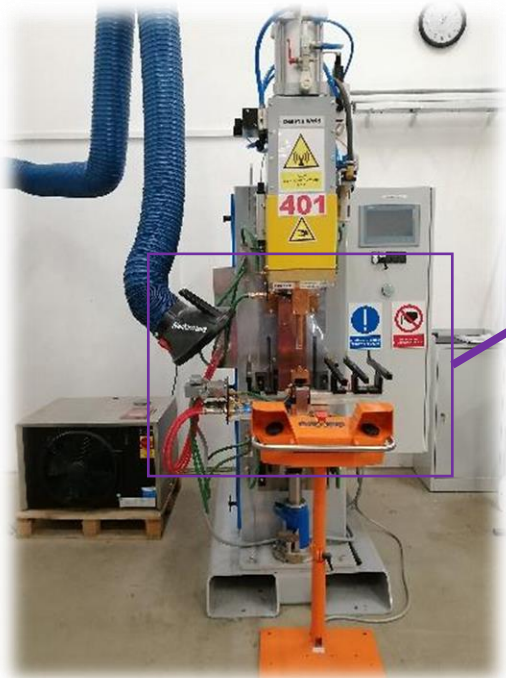

Ostatní technologie

Zalisování matic (náhrada navařovaných matic)

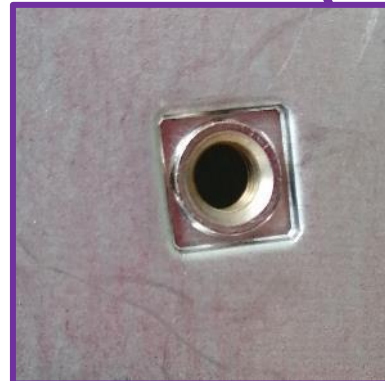
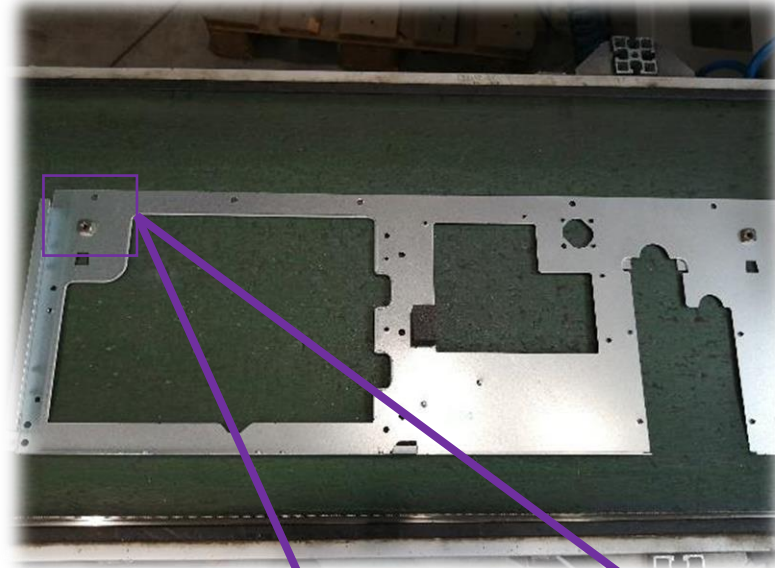

Ostatní technologie

Laserování QR kódů

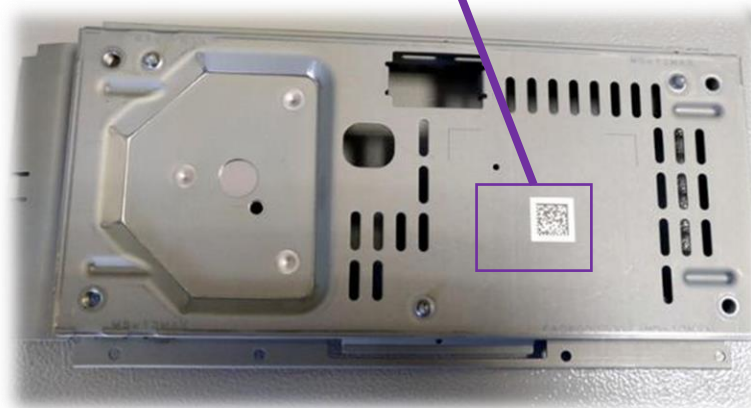

KeyTec Ceske Budejovice

Montáž

KeyTec
PRECISION COMPONENTS

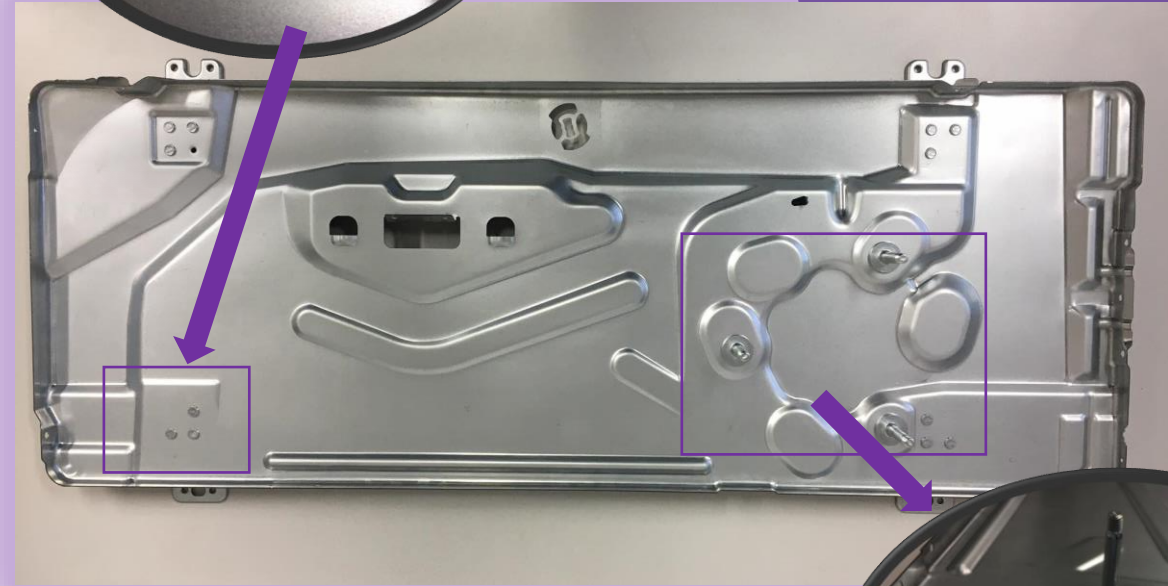
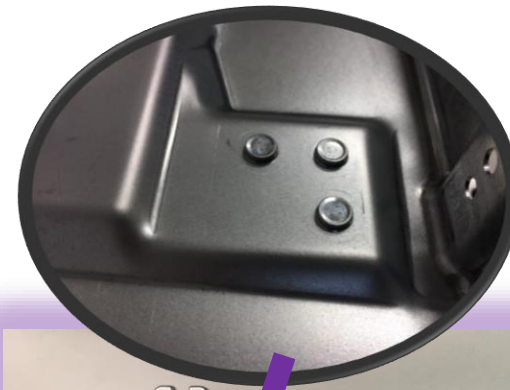

KeyTec Ceske Budejovice

Montáž & Vizualní kontrola

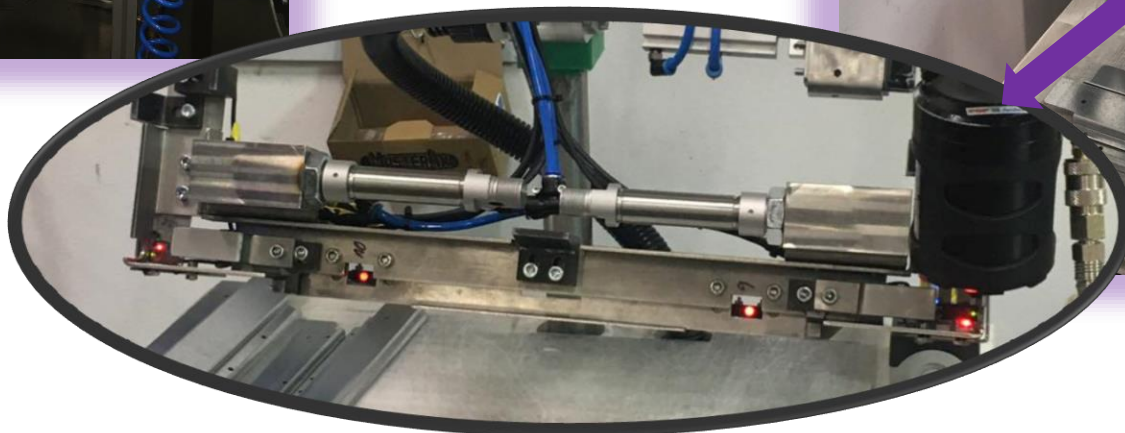

Ostatní technologie

Odmaštění



A další...

- Nýtování
- Toxování
- Ruční a poloautomatické montáže
- Odhrotování

Konstrukční oddělení

- Konstrukční kancelář o 3 stanicích, využívající software:

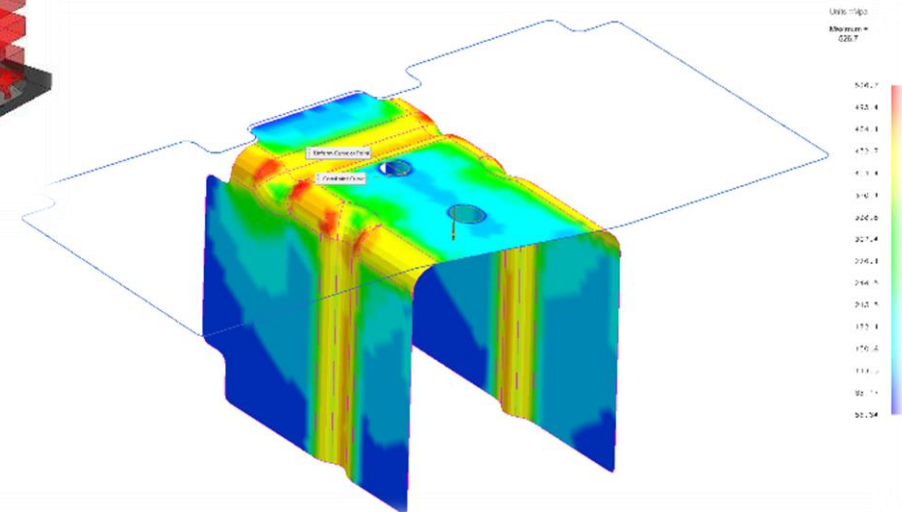
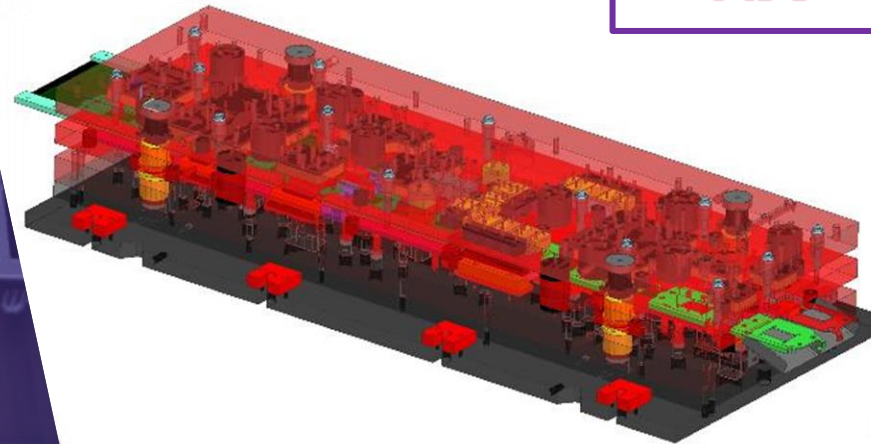

Nástrojárna

- Vlastní nástrojárna, která se stará o údržbu a opravu více než 1000 nástrojů



MĚŘÍCÍ TECHNIKA

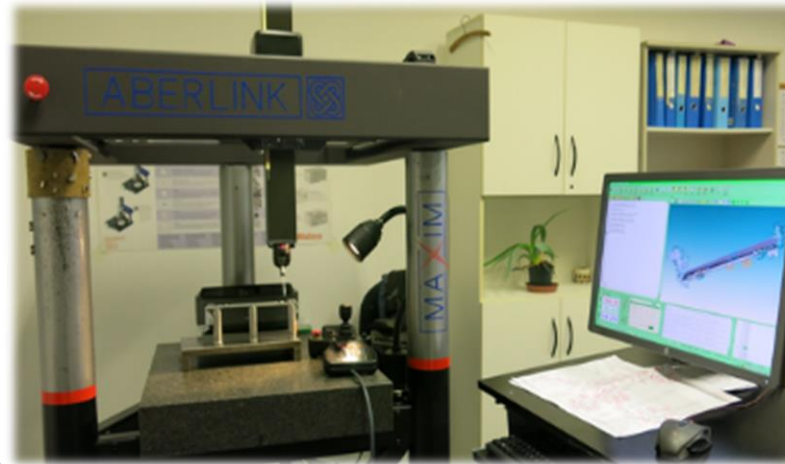

3D CNC ABERLINK MAXIM
Rozsah měření 600 x 500 x 400 mm
SW Renishaw MODUS

3D CNC EQUATOR Renishaw
Rozsah měření 300x300x150 mm
SW Renishaw MODUS



Číslo	Skupina	Jmen.	Rezi	H.ř.	Š.ř.	Chyba
CI004	Skupina	Jmen.	Rezi	H.ř.	Š.ř.	Chyba
Průměr	10.76	10.00	0.76	0.20	-0.76	0.00
Im. při 20	0.08	0.00	0.08	0.00	+	0.00
CI003	Skupina	Jmen.	Rezi	H.ř.	Š.ř.	Chyba
Průměr	10.76	10.00	0.76	0.20	-0.76	0.00
Im. při 20	0.12	0.00	0.12	0.00	+	0.00
CI002	Skupina	Jmen.	Rezi	H.ř.	Š.ř.	Chyba
Průměr	8.08	8.00	0.08	0.20	0.10	0.00
Im. při 20	0.08	0.00	0.08	0.00	+	0.00
CI001	Skupina	Jmen.	Rezi	H.ř.	Š.ř.	Chyba
Průměr	8.08	8.00	0.08	0.20	-0.00	0.00
Im. při 20	0.08	0.00	0.08	0.00	+	0.00
CI005	Skupina	Jmen.	Rezi	H.ř.	Š.ř.	Chyba
Průměr	16.18	16.00	0.18	0.20	-0.10	0.00
Im. při 20	0.10	0.00	0.10	0.00	+	0.00
CI006	Skupina	Jmen.	Rezi	H.ř.	Š.ř.	Chyba
Průměr	20.28	20.00	0.28	0.40	-0.10	0.00
Im. při 20	0.10	0.00	0.10	0.00	+	0.00



MĚŘÍCÍ TECHNIKA

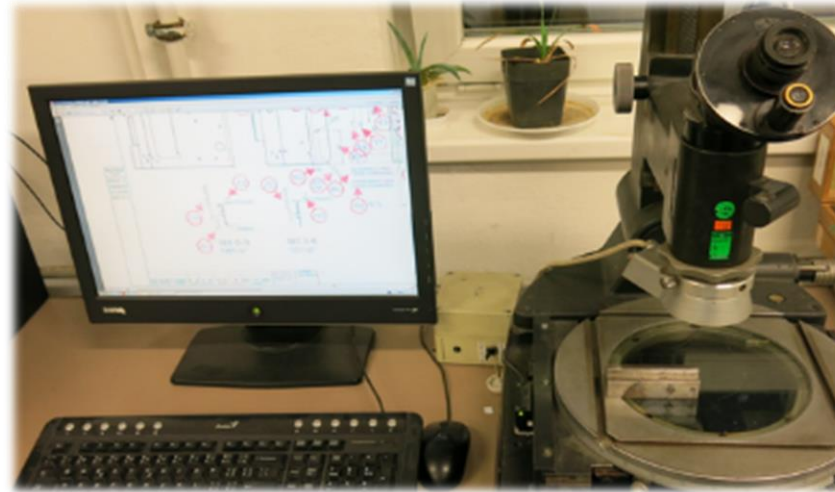

Mikroskop Carl Zeiss
Rozsah měření 100x50 mm
SW TANGO



Vertex 310
Optické 3D měření

CERTIFIKACE

ISO 9001:2015

ISO 14001:2015

CERTIFICATE
No. 42013339

This is to certify the Quality Management System of

KeyTec
KeyTec České Budějovice s.r.o.
Novohradská 1764
370 21 České Budějovice, České Budějovice 6
Czech Republic

has been assessed and found to be in compliance with the Standard
ISO 9001:2015
applicable to
Production and assembly of stamped metal parts for automotive, electrical and ICT industry.

The certificate has been issued under No. 42013339 for the registration period from 05 February 2020 to 04 February 2023.
The first certificate date of issue is 01 February 2014.

Approved by: [Signature] Printed by: [Signature]

validity code **B922F97E-158**
Check the validity of this certificate using this code at www.ll-c.info
LL-C (Certification) Czech Republic a.s. | Pobožní 620/3, 186 00 Praha 8

CERTIFICATE
No. 42013339

This is to certify the Environmental Management System of

KeyTec
KeyTec České Budějovice s.r.o.
Novohradská 1764
370 21 České Budějovice, České Budějovice 6
Czech Republic

has been assessed and found to be in compliance with the Standard
ISO 14001:2015
applicable to
Production and assembly of stamped metal parts for automotive, electrical and ICT industry.

The certificate has been issued under No. 42013339 for the registration period from 05 February 2020 to 04 February 2023.
The first certificate date of issue is 01 February 2014.

Approved by: [Signature] Printed by: [Signature]

validity code **AA6541F1-D9F**
Check the validity of this certificate using this code at www.ll-c.info
LL-C (Certification) Czech Republic a.s. | Pobožní 620/3, 186 00 Praha 8



Panasonic

Signify

SIEMENS



Audi



NISSAN



TOYOTA



RENAULT



PHILIPS



Naši zákazníci

- Nadnárodní
- Celosvětové zaměření
- Proaktivní
- Zero-defect Quality

“Powerful in Metal combinations”



VYUŽITÍ NAŠICH PRODUKTŮ

Součásti klimatizací Daikin

KeyTec produkty

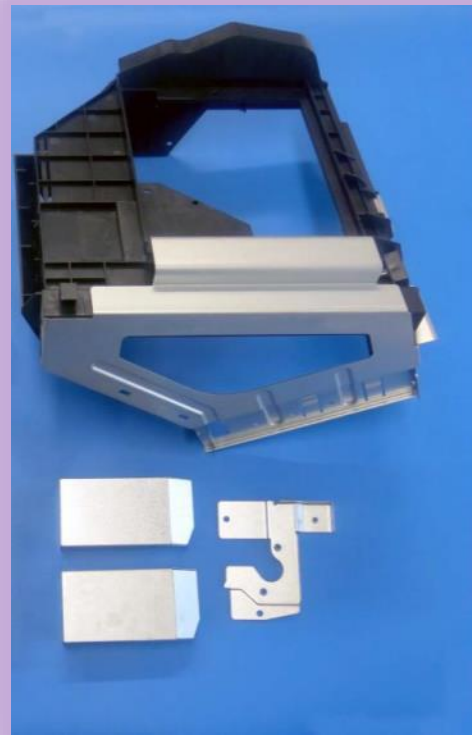

KeyTec Ceske Budejovice

VYUŽITÍ NAŠICH PRODUKTŮ

Součásti klimatizací Daikin

KeyTec
PRECISION COMPONENTS

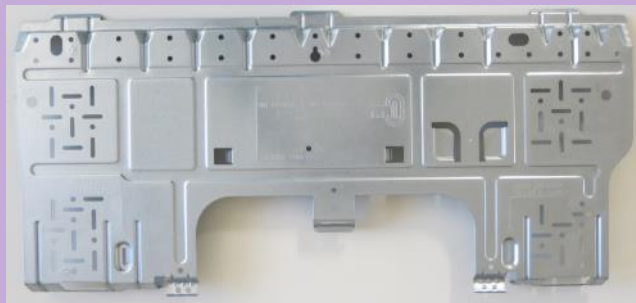

VYUŽITÍ NAŠICH PRODUKTŮ

Součásti klimatizací Daikin



Top Grade 180 DAH-230L 13.1 kW



R-32



KeyTec Ceske Budejovice

VYUŽITÍ NAŠICH PRODUKTŮ

Součásti klimatizací Daikin (vnitřní jednotka)

KeyTec
PRECISION COMPONENTS



DAIKIN

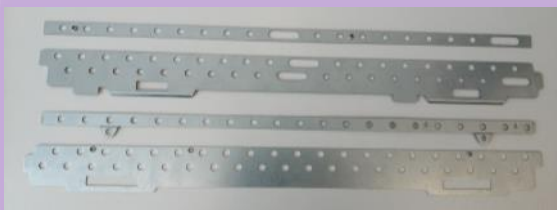

KeyTec Ceske Budejovice

VYUŽITÍ NAŠICH PRODUKTŮ

Součásti tepelných čerpadel Daikin

KeyTec
PRECISION COMPONENTS



DAIKIN

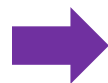

KeyTec Ceske Budejovice

VYUŽITÍ NAŠICH PRODUKTŮ

Součásti tepelných čerpadel Daikin

KeyTec
PRECISION COMPONENTS

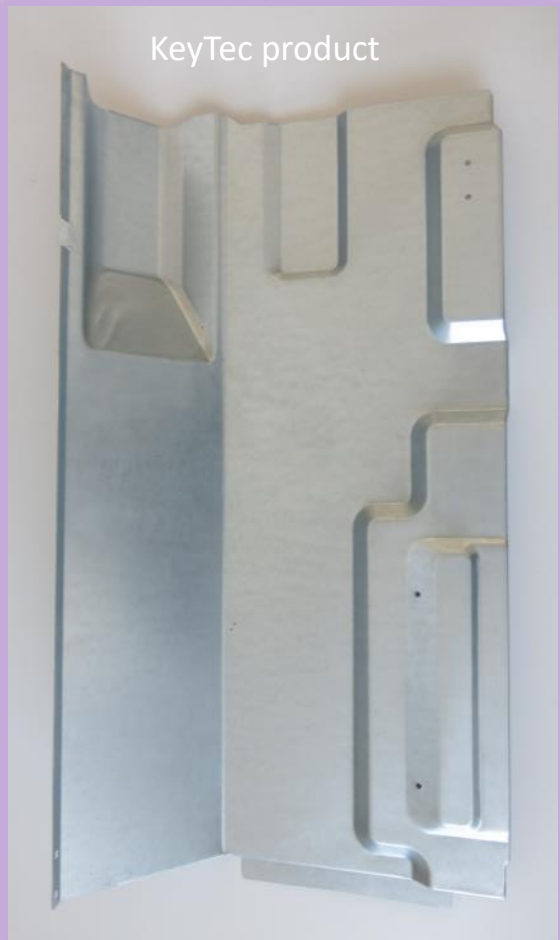

DAIKIN

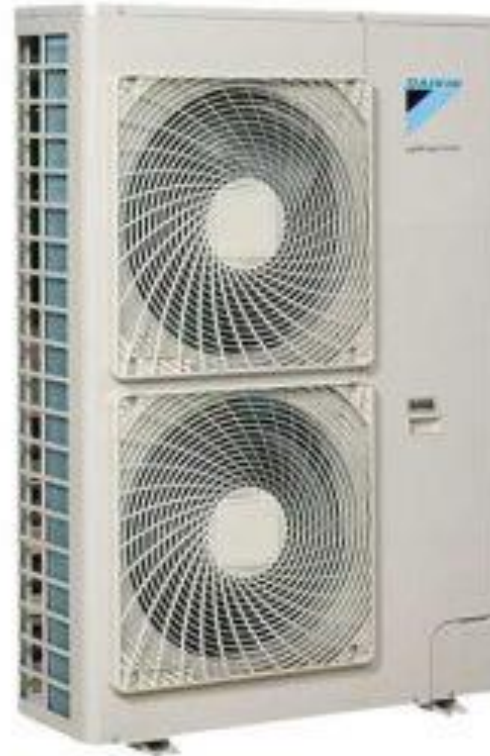

VYUŽITÍ NAŠICH PRODUKTŮ

Součásti tepelných čerpadel Daikin



VYUŽITÍ NAŠICH PRODUKTŮ

Nárazníky Nissan Juke

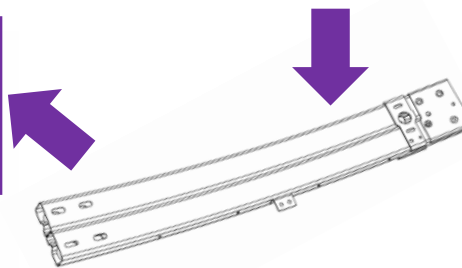
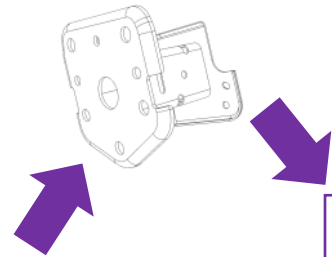

VYUŽITÍ NAŠICH PRODUKTŮ

Nárazník Renault Espace



VYUŽITÍ NAŠICH PRODUKTŮ

Komponenty pro elektrické vozy BMW



VYUŽITÍ NAŠICH PRODUKTŮ

Nárazníky Nissan Micra

KeyTec products

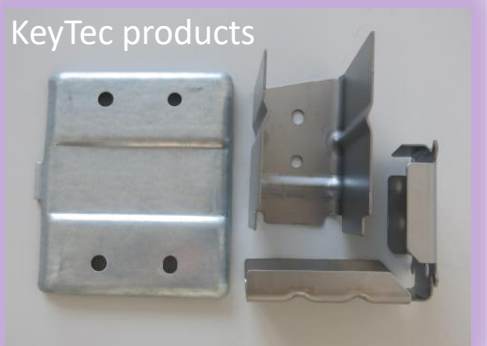

KeyTec products



KeyTec products

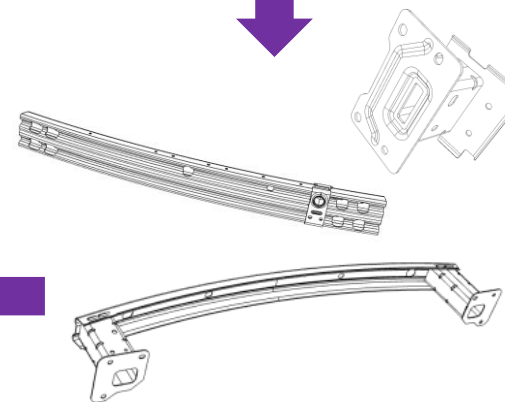
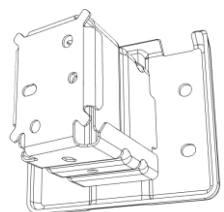

VYUŽITÍ NAŠICH PRODUKTŮ

Pojezdy sedaček VW Amarok



VYUŽITÍ NAŠICH PRODUKTŮ

Infotainment Mercedes M, GL, SLK, CLS, A, B

KeyTec product

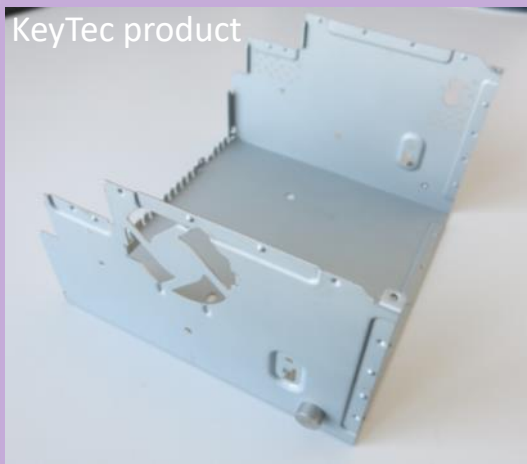

VYUŽITÍ NAŠICH PRODUKTŮ

Infotainment Audi A1 / Q3

KeyTec product

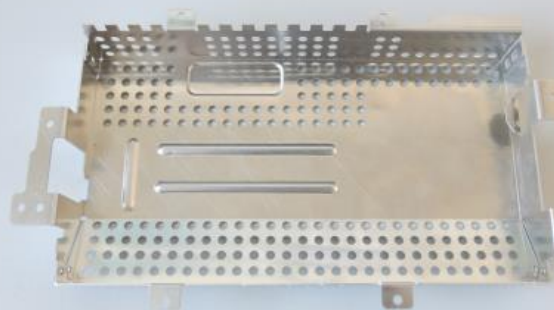

KeyTec Ceske Budejovice

VYUŽITÍ NAŠICH PRODUKTŮ

Infotainment Range Rover Velar

KeyTec
PRECISION COMPONENTS



VYUŽITÍ NAŠICH PRODUKTŮ

Infotainment VW Golf

KeyTec products

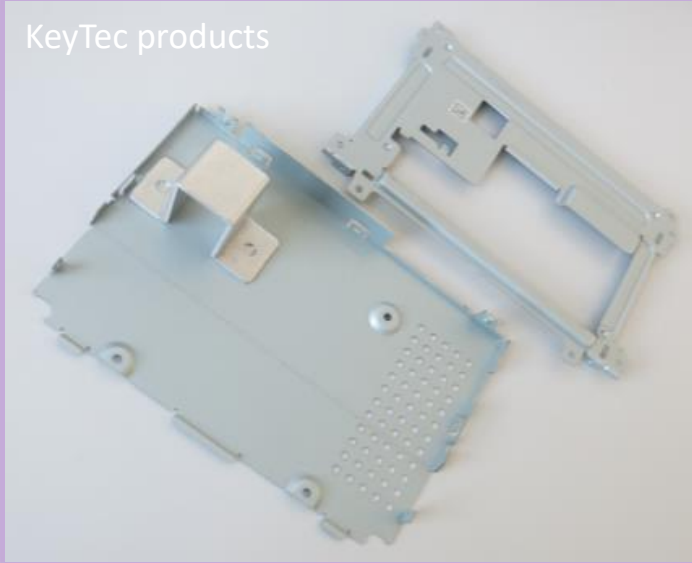

VYUŽITÍ NAŠICH PRODUKTŮ

Předřadníky interiérových zářivek Signify (Philips)

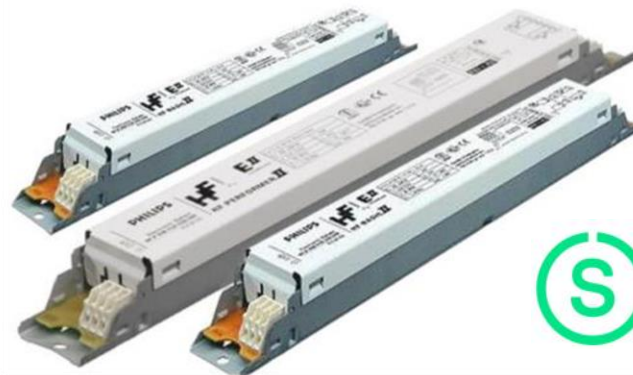
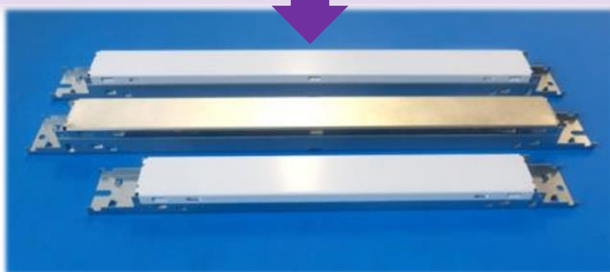

Signify

VYUŽITÍ NAŠICH PRODUKTŮ

Řídící jednotka elektroniky pro průmyslové skleníky

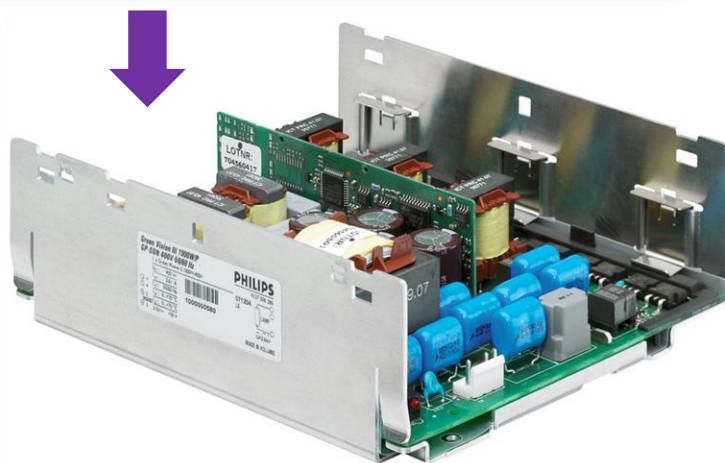

VYUŽITÍ NAŠICH PRODUKTŮ

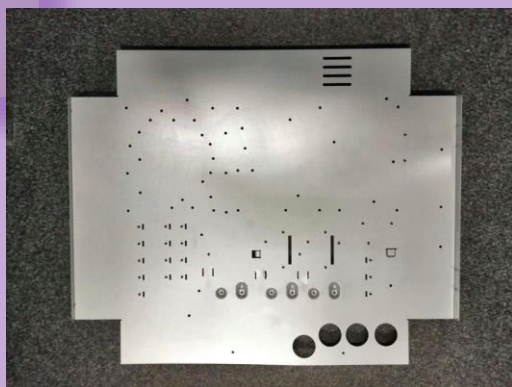

VYUŽITÍ NAŠICH PRODUKTŮ

Součásti semaforů Swarco

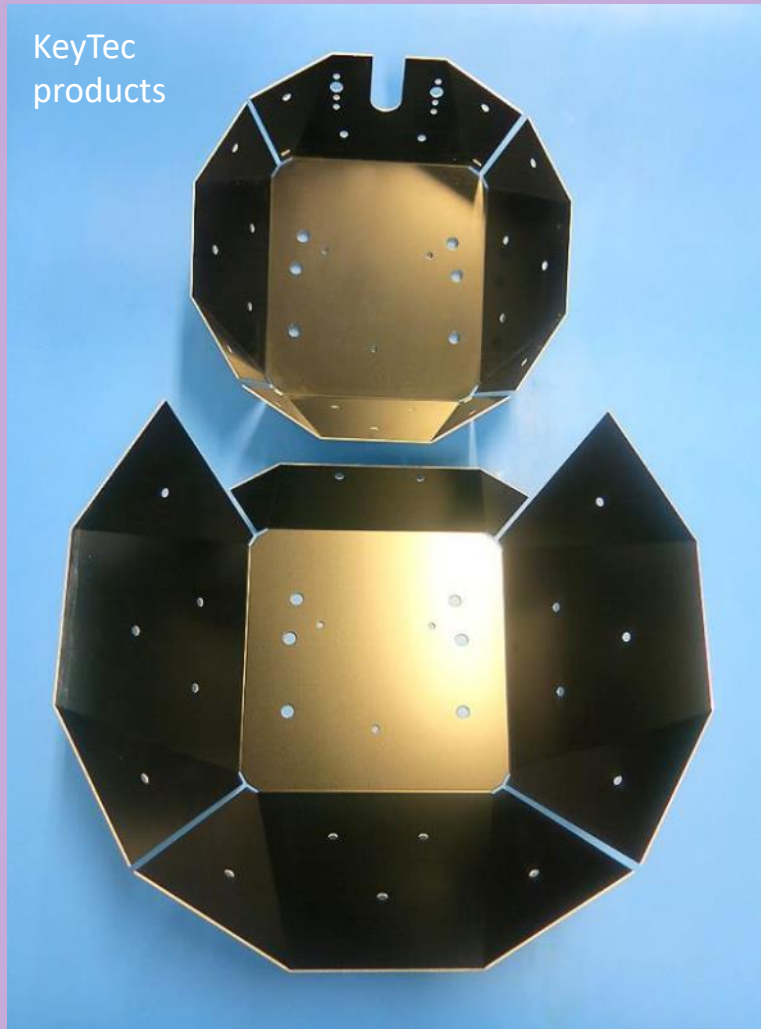

Kontakty

Business Development Department:

- gerard.staes@keytec.cz
- marcel.vlk@keytec.cz
- josef.lastuvka@keytec.cz
- vojtech.svarc@keytec.cz
- jan.prachar@keytec.cz



KeyTec
PRECISION COMPONENTS





“We Industrialize Your Idea”

www.KeyTecGroup.com

