

KeyTec
České Budějovice

KeyTec's mission

KeyTec provides Metal parts and their combination in Mechatronic Manufacturing Solutions (MMS) for various application areas.

We are a reliable partner during the product life cycle for customers with a focus on technology and innovation.

“We Industrialize Your Idea”





KeyTec's strategy

- Engineering & Manufacturing
- Metal technologies
- Creating integrated modules/products
- One roof concept
- Reliability and Trust

“Powerful in Metal combinations”

KeyTec Ceske Budejovice

LOCATION



KeyTec
PRECISION COMPONENTS

Novohradská 1764
370 01 České Budějovice
keytec@keytec.cz
www.keytec.cz
+420 389 002 111
CZECH REPUBLIC

GENERAL INFO

- Established in 1994
- 350 colleagues
- 22 000 m2 floorspace
- Annual revenues more than 40 mil. EUR

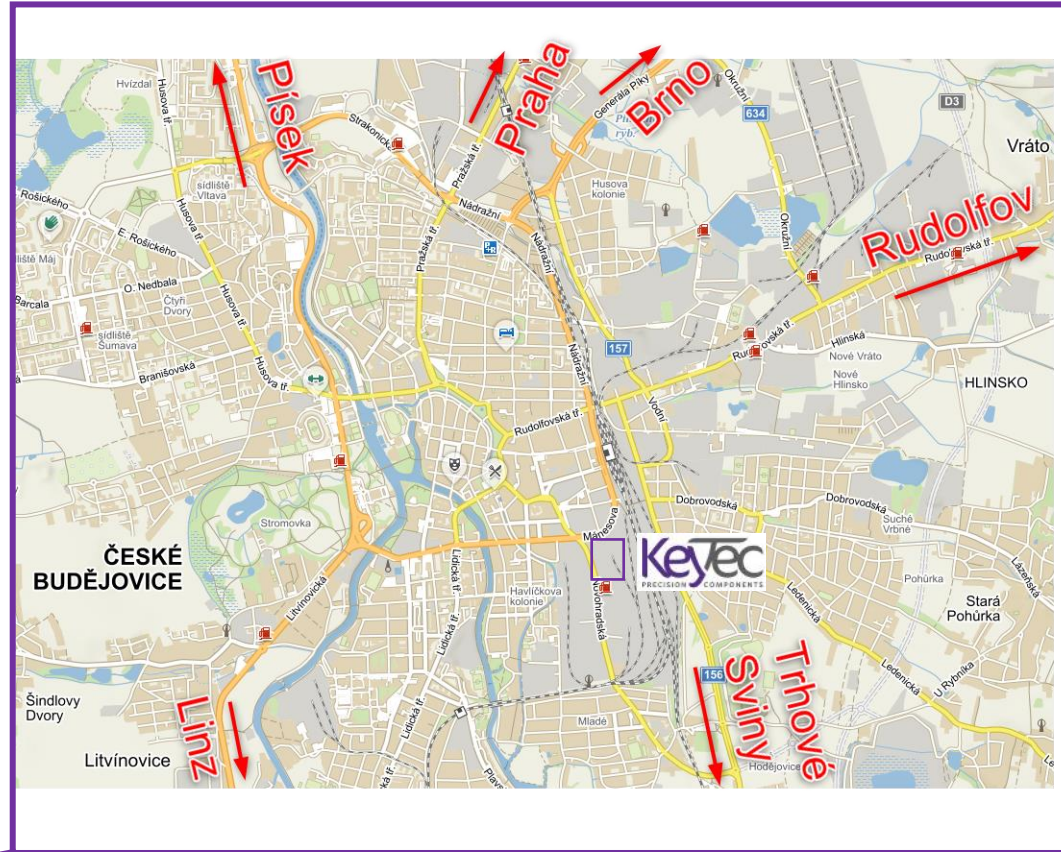
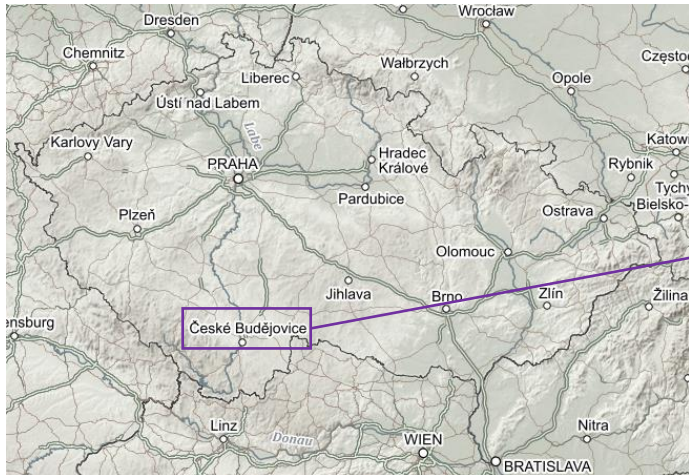

MAIN TECHNOLOGY

Progressive metal stamping



Aida 630 t



EBU 630 t

19 press lines:

- 160 - 630 tons (servo and eccentric presses)
- Max tool dimensions 4000x1500 mm
- Kaiser, Müller, Beutler Nova, Aida, EBU Burkhardt
- Thickness 0,3 – 8 mm
- Processing of hightensile steel

MAIN TECHNOLOGY

Metal stamping

Robotic tandem line

- 5 x SIMPAC 200 to 1500 x 900 mm
- 7 x KUKA KR IONTEC 50
- Oiling and centering table SAGOMA 1000

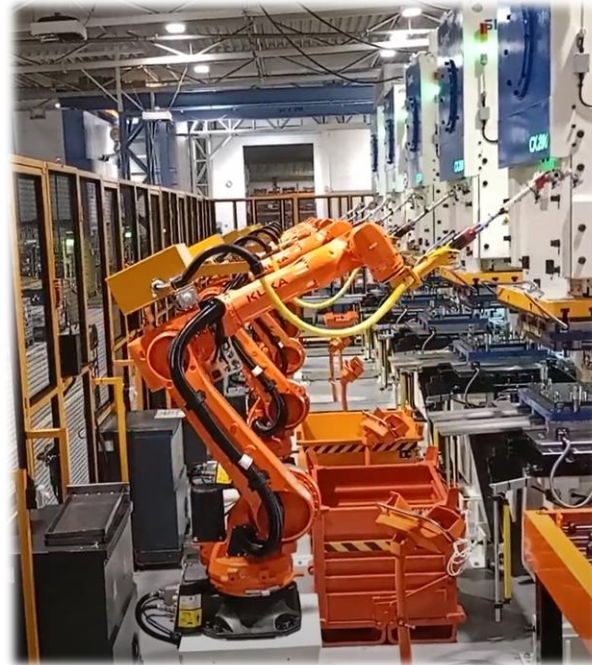
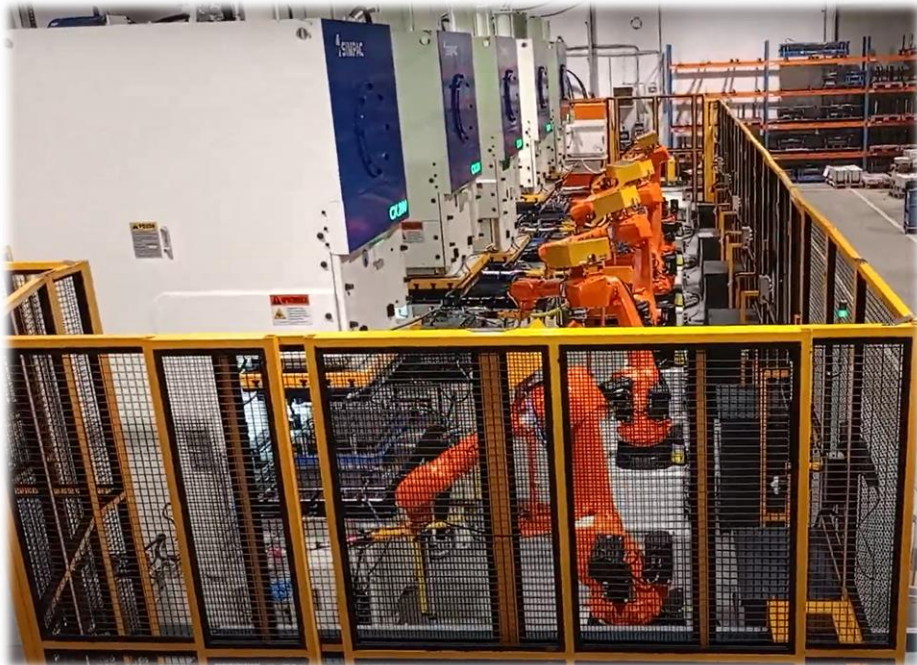

MAIN TECHNOLOGY

Metal stamping

Transfer line

- 6 x Aida 200 tons 1390 x 840 mm



Transfer line

26 individual presses:

- 100 - 250 tons
- Max tool dimensions 1250 x 750 mm
- Müller, Aida, Beutler Nova



Aida 250 t

OTHER TECHNOLOGY

Threadforming (M2-M10)

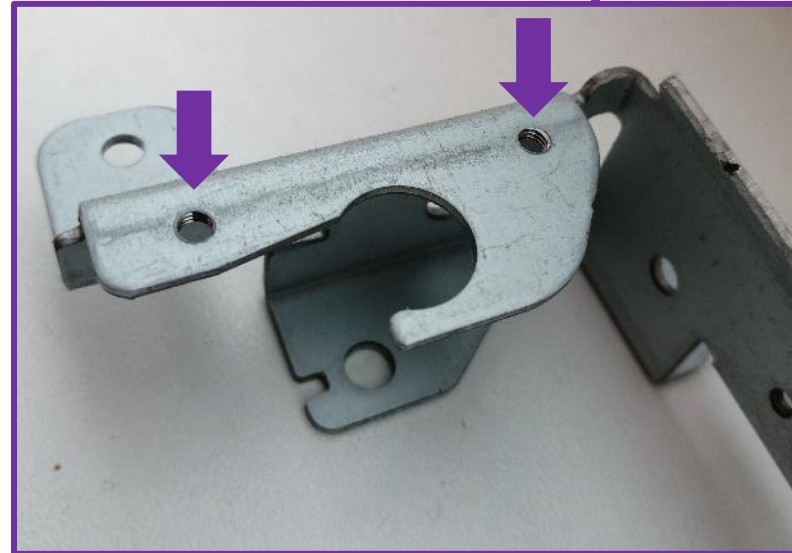

OTHER TECHNOLOGY

Projection welding (nut welding)

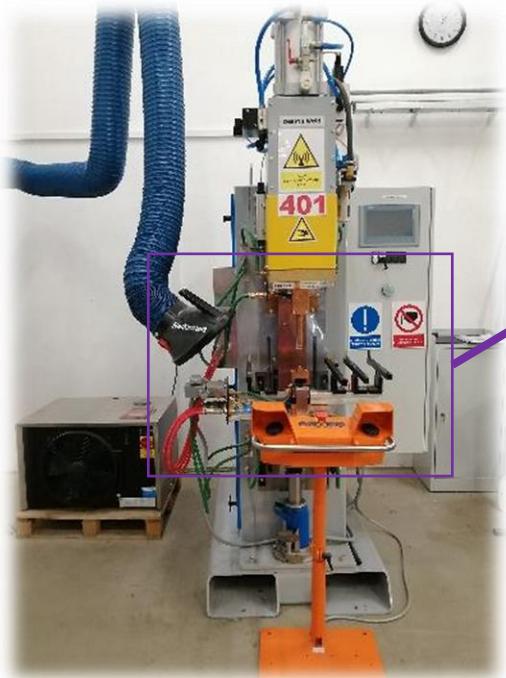

OTHER TECHNOLOGY

Press nut assembly (replacement of welding)

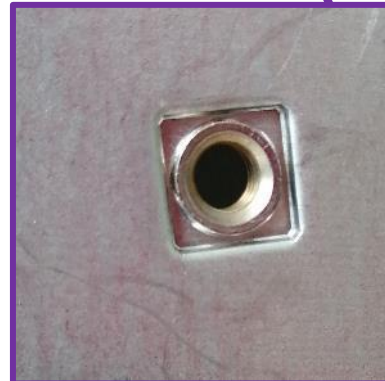
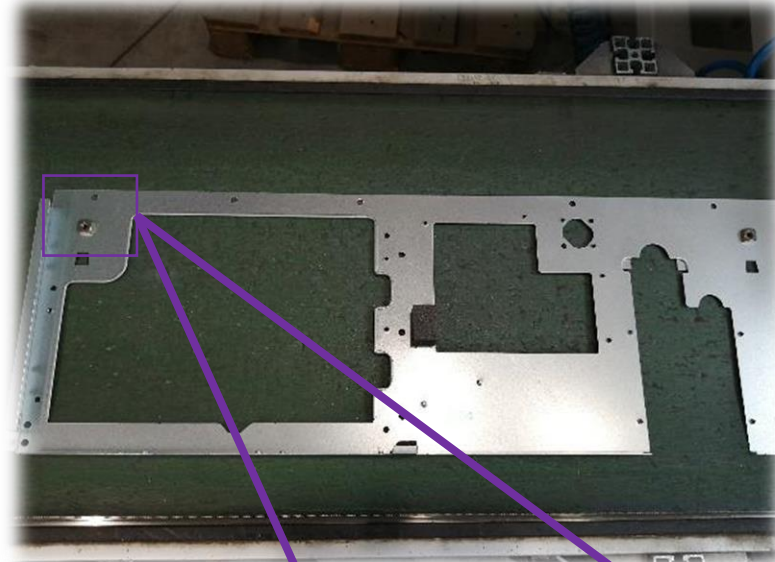

OTHER TECHNOLOGY

Laser marking (QR)

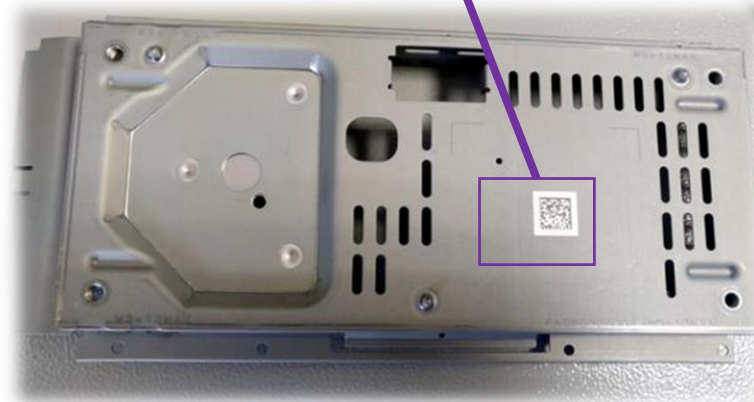

KeyTec Ceske Budejovice Assembly

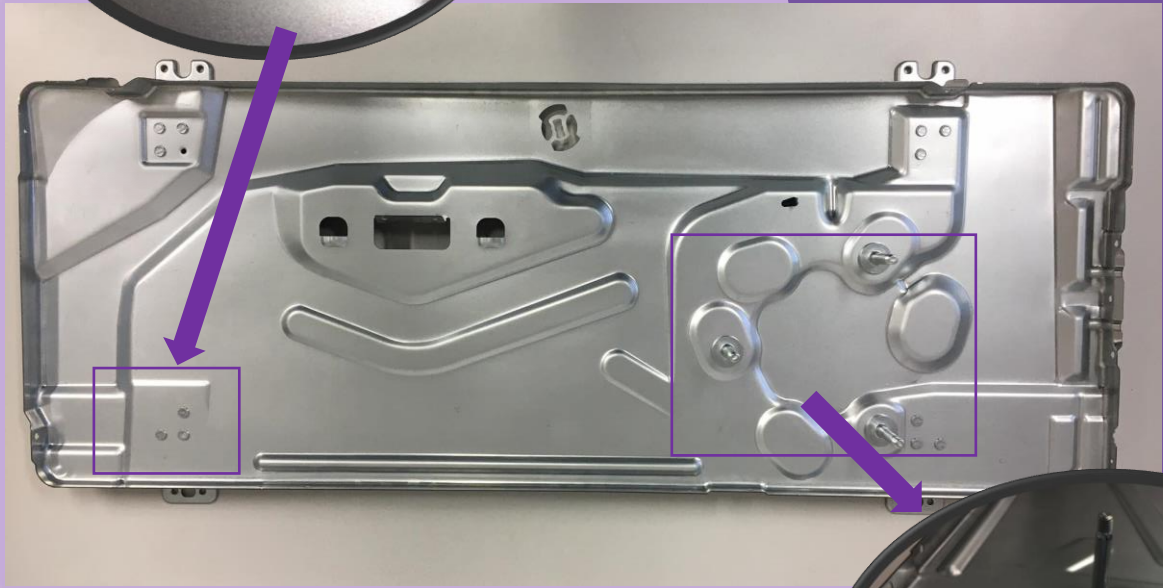
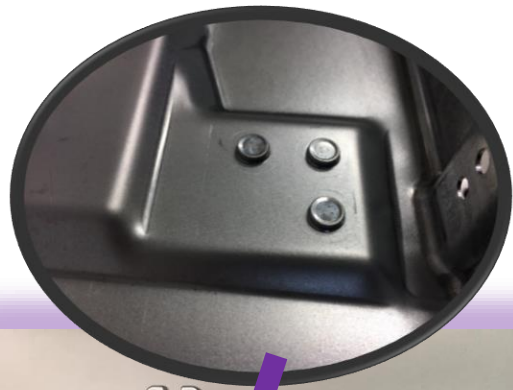

KeyTec Ceske Budejovice

Assembly & Visual control

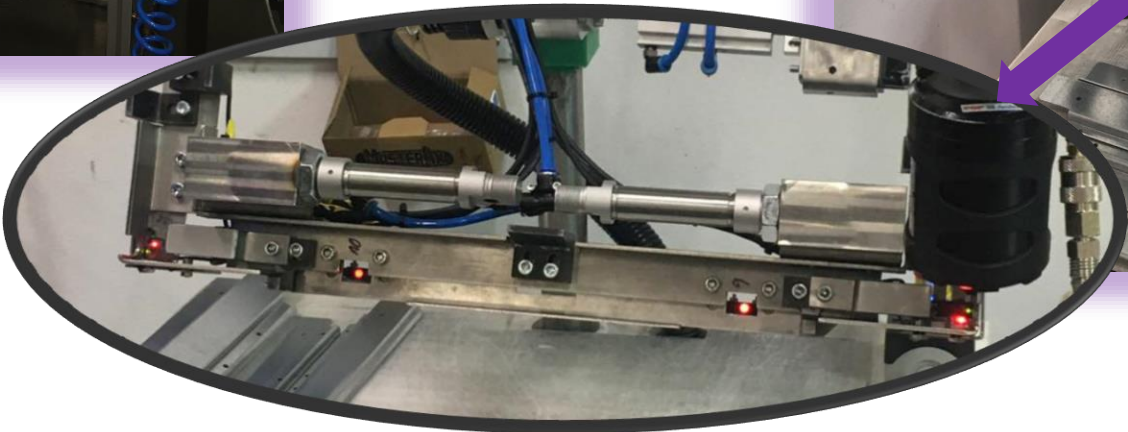
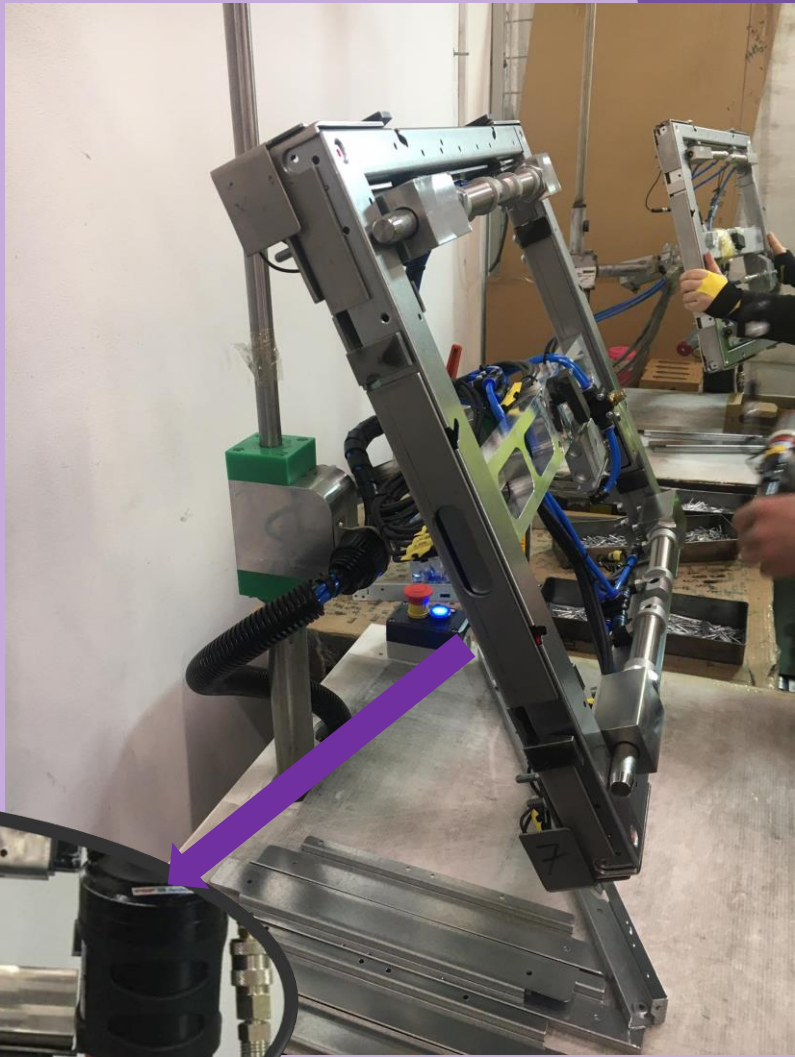

OTHER TECHNOLOGY

Degreasing



And others...

- Riveting
- Toxing
- Assembly
- Deburring

CONSTRUCTION DEPARTMENT

- Our own construction office using following software:

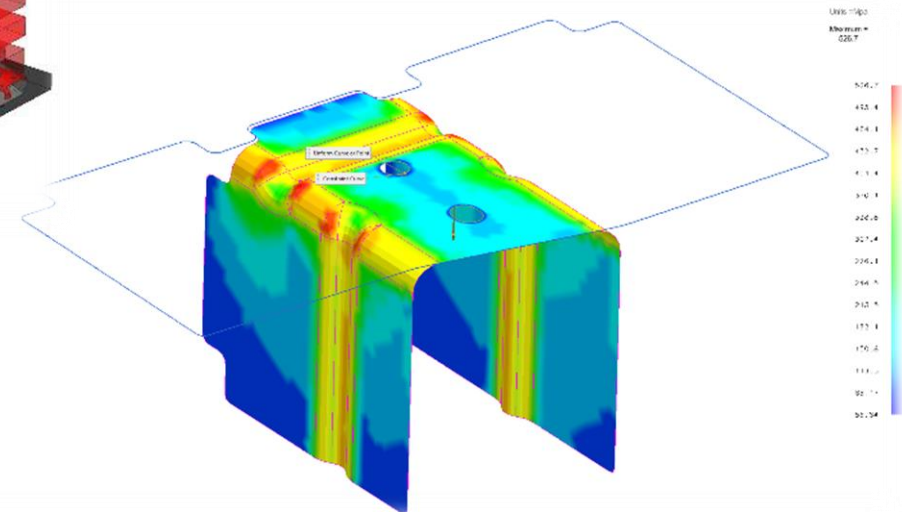
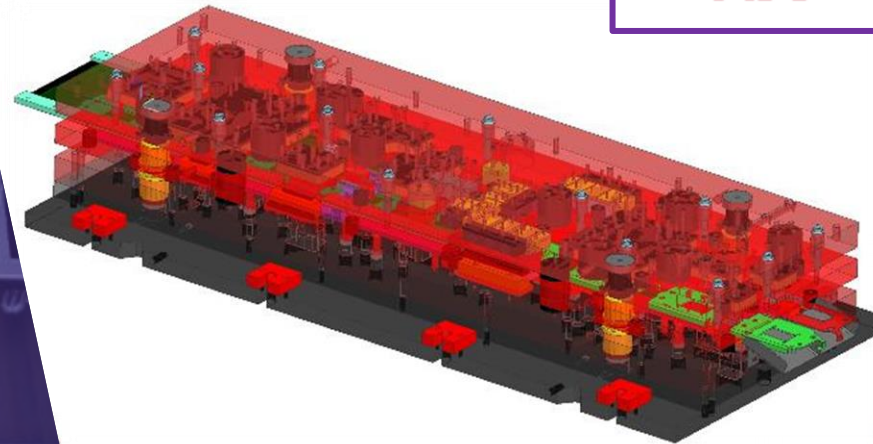

TOOL SHOP

- Our own tool shop, who maintains and repairs over 1000 tools



MEASURING EQUIPMENT

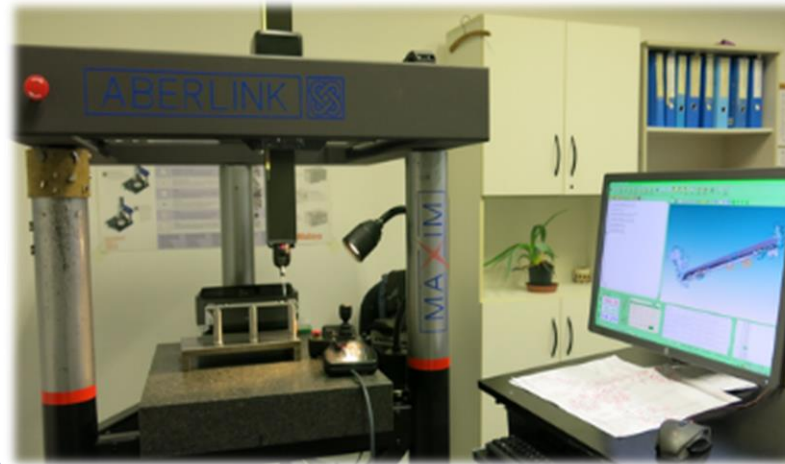

3D CNC ABERLINK MAXIM
Range of measurement 600x500x400 mm
SW Renishaw MODUS

3D CNC EQUATOR Renishaw
Range of measurement 300x300x150 mm
SW Renishaw MODUS



CI004	Skúška	Jmen.	Rezi	H.úř	D.úř	Čtyř
Průměr	16.16	16.00	0.16	0.20	-0.10	0.00
Im.úř.2D	0.08	0.08	0.08	0.08	+	0.00

CI003	Skúška	Jmen.	Rezi	H.úř	D.úř	Čtyř
Průměr	16.16	16.00	0.16	0.20	-0.10	0.00
Im.úř.2D	0.12	0.00	0.12	0.00	+	0.00

CI002	Skúška	Jmen.	Rezi	H.úř	D.úř	Čtyř
Průměr	8.08	8.00	0.08	0.20	0.10	0.00
Im.úř.2D	0.08	0.00	0.08	0.08	+	0.00

CI001	Skúška	Jmen.	Rezi	H.úř	D.úř	Čtyř
Průměr	8.08	8.00	0.08	0.20	-0.10	0.00
Im.úř.2D	0.08	0.00	0.08	0.08	+	0.00

CI1001	Skúška	Jmen.	Rezi	H.úř	D.úř	Čtyř
Úhla	20.28	20.00	0.28	0.40	-0.10	0.00
Úhla	8.30	8.00	0.30	0.00	-0.10	0.00

CI001	Skúška	Jmen.	Rezi	H.úř	D.úř	Čtyř
Průměr	16.16	16.00	0.16	0.20	-0.10	0.00



MEASURING EQUIPMENT

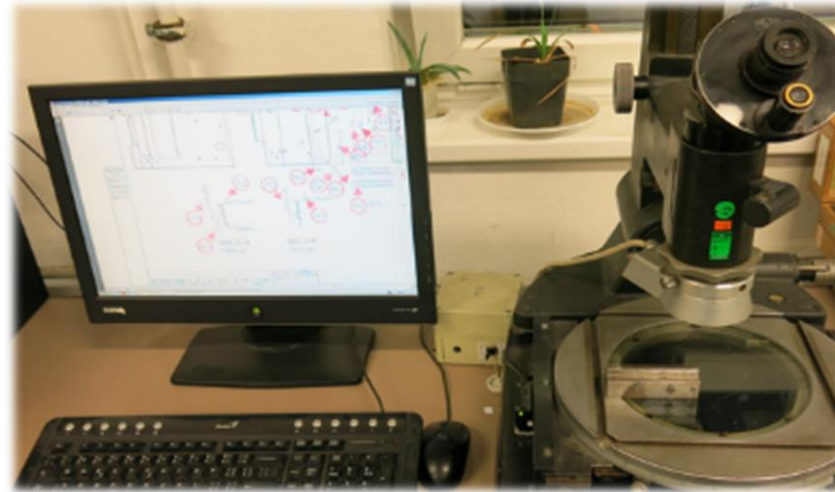

Mikroskope Carl Zeiss
Range of measurement 100x50 mm
SW TANGO



Vertex 310
Optical 3D measurement

CERTIFICATION

ISO 9001:2015

ISO 14001:2015





KeyTec group

Our customers

- Multinational
- Worldwide focus
- Pro active
- Zero-defect Quality

“Powerful in Metal combinations”



USAGE OF OUR PRODUCTS

Aircondition components Daikin

KeyTec products

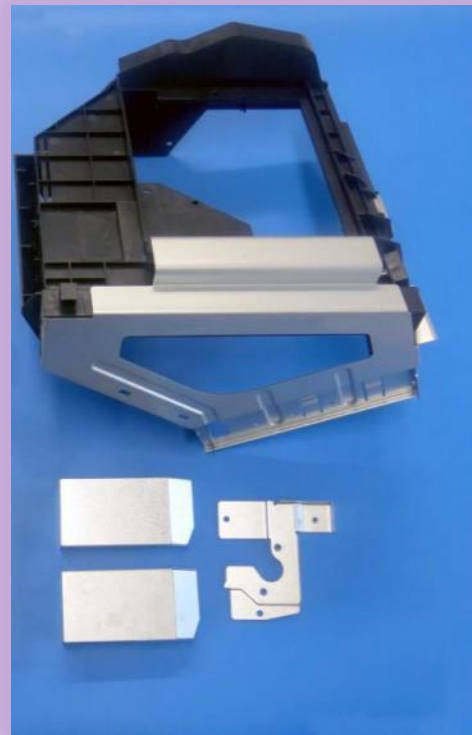
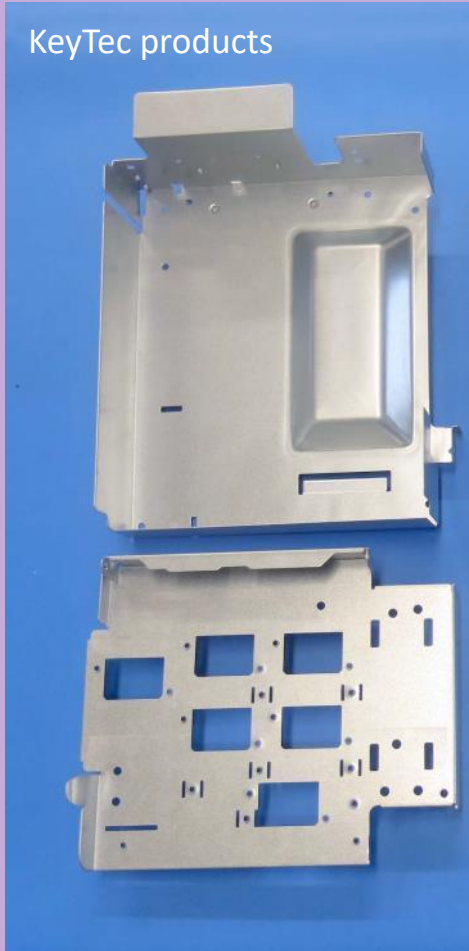

USAGE OF OUR PRODUCTS

Aircondition components Daikin

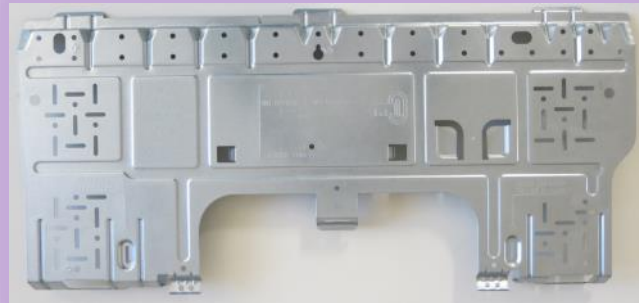
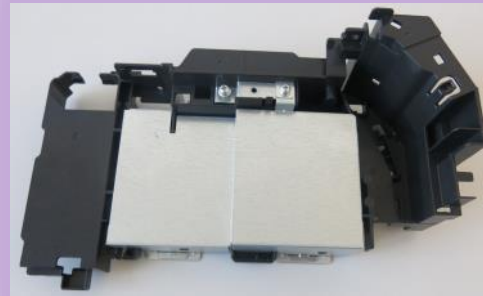

USAGE OF OUR PRODUCTS

Aircondition components Daikin



USAGE OF OUR PRODUCTS

Aircondition components Daikin (indoor unit)

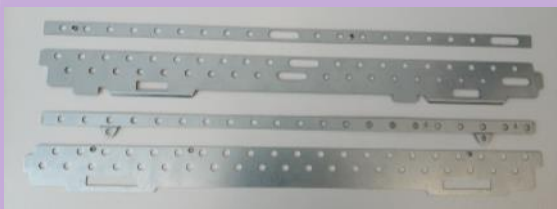

USAGE OF OUR PRODUCTS

Heat pump components Daikin



USAGE OF OUR PRODUCTS

Heat pump components Daikin

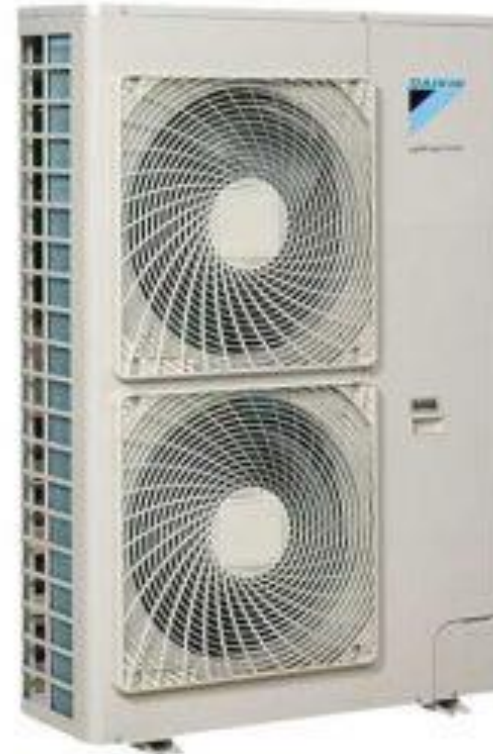

USAGE OF OUR PRODUCTS

Heat pump components Daikin

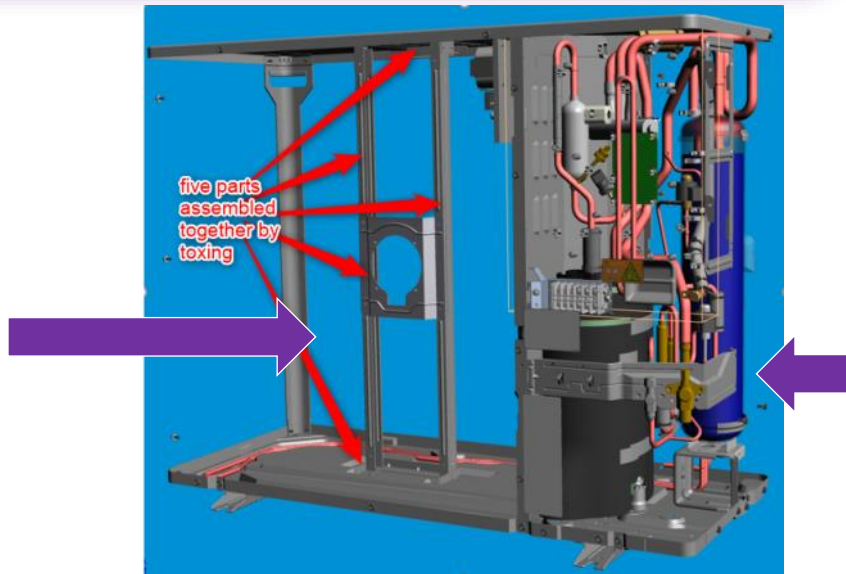
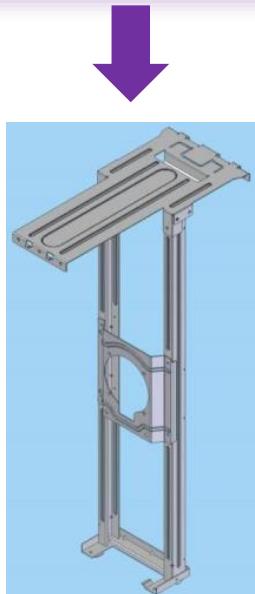

USAGE OF OUR PRODUCTS

Bumpers Nissan Juke

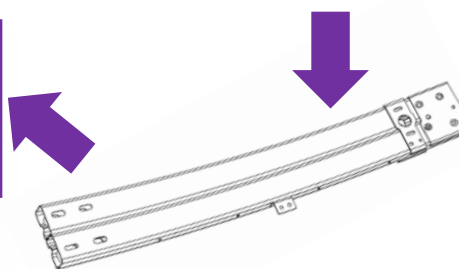
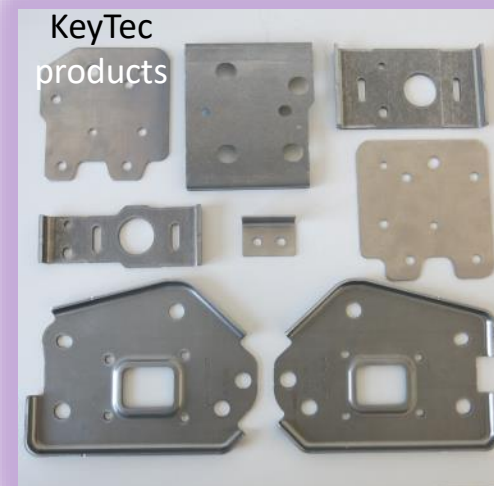
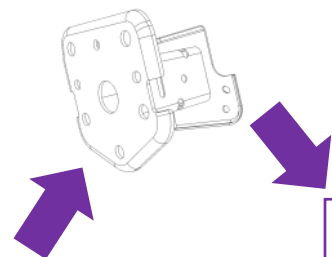

USAGE OF OUR PRODUCTS

Components for BMW's EV



USAGE OF OUR PRODUCTS

Bumper Renault Espace



USAGE OF OUR PRODUCTS

Bumpers Nissan Micra

KeyTec products

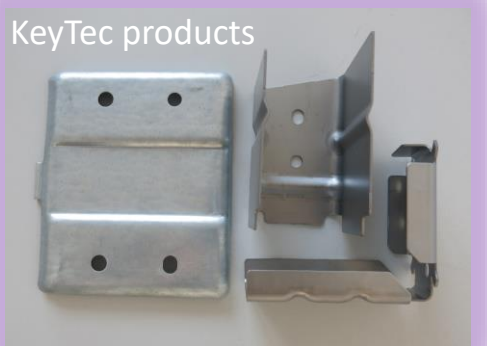

KeyTec products



KeyTec products

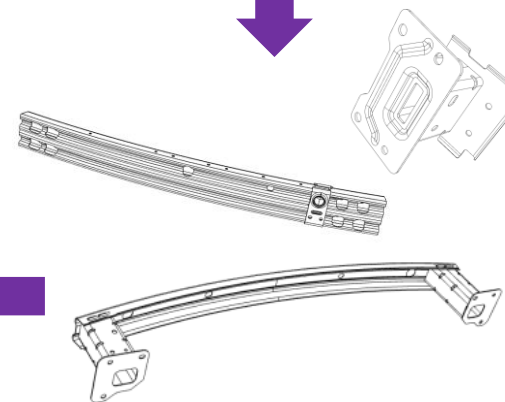
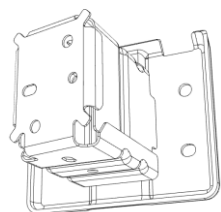

USAGE OF OUR PRODUCTS

Seats rails VW Amarok

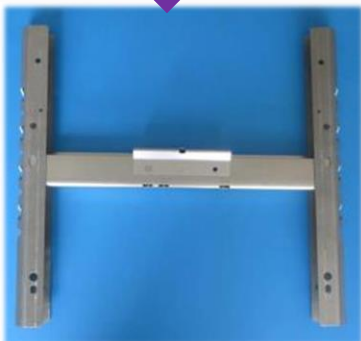

USAGE OF OUR PRODUCTS

Infotainment Mercedes M, GL, SLK, CLS, A, B

KeyTec product

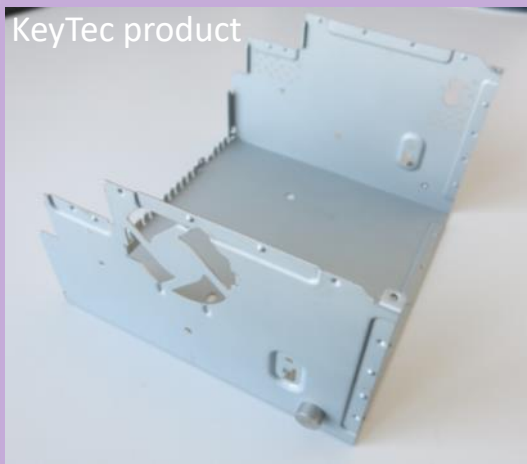

USAGE OF OUR PRODUCTS

Infotainment Audi A1 / Q3

KeyTec product

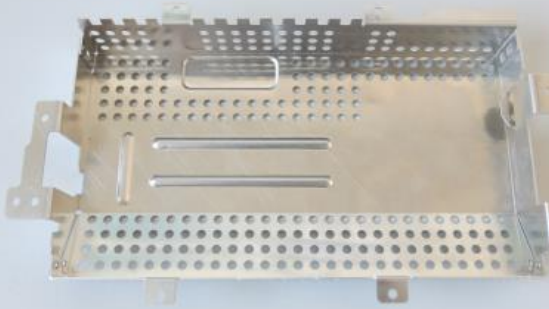

Q3

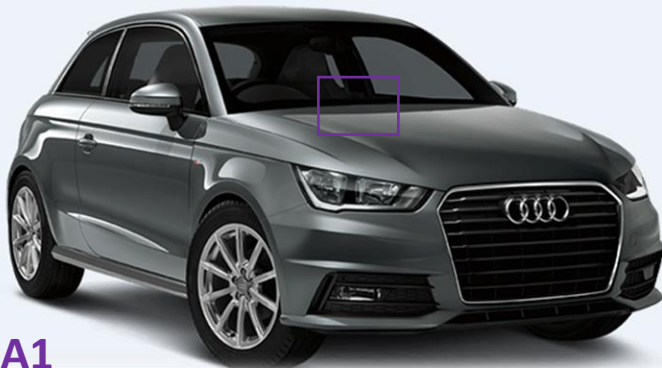

A1



USAGE OF OUR PRODUCTS

Infotainment Range Rover Velar

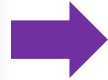

USAGE OF OUR PRODUCTS

Infotainment VW Golf

KeyTec products

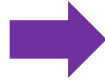
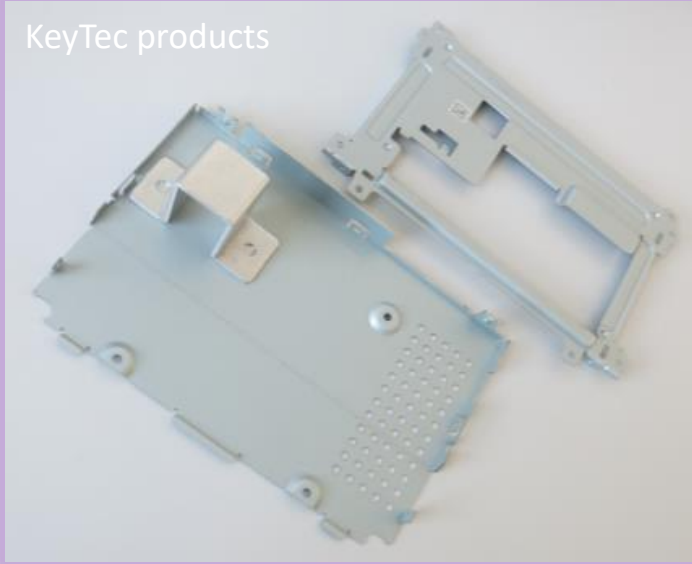

USAGE OF OUR PRODUCTS

Lighting components Signify (Philips)

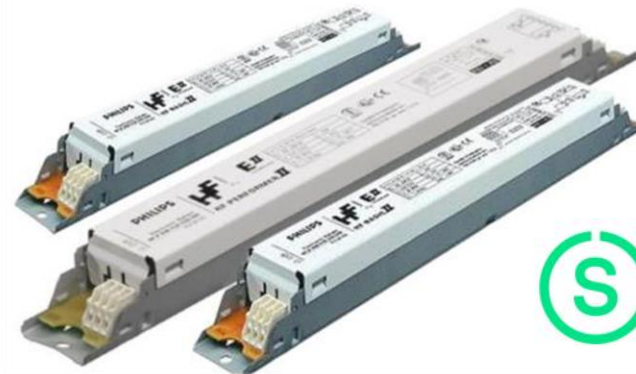
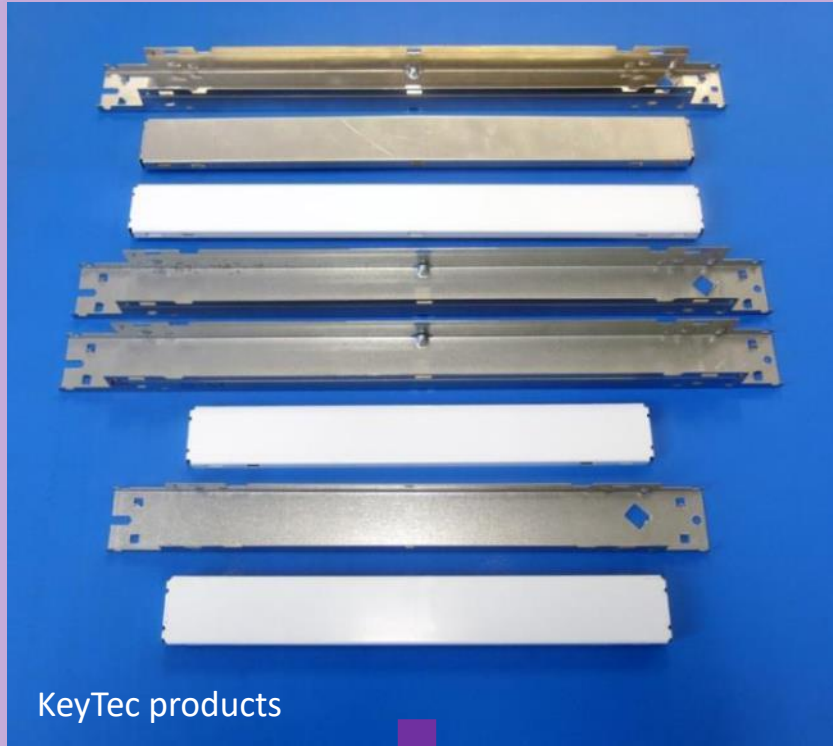

Signify



USAGE OF OUR PRODUCTS

Control unit for greenhouse heating / lighting

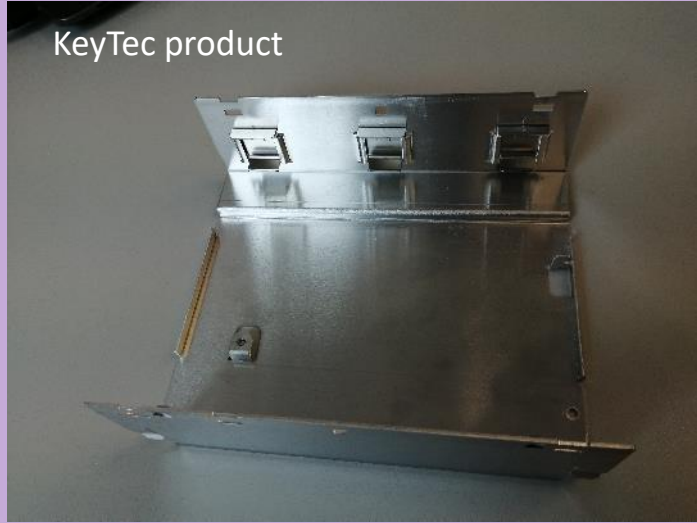

Signify

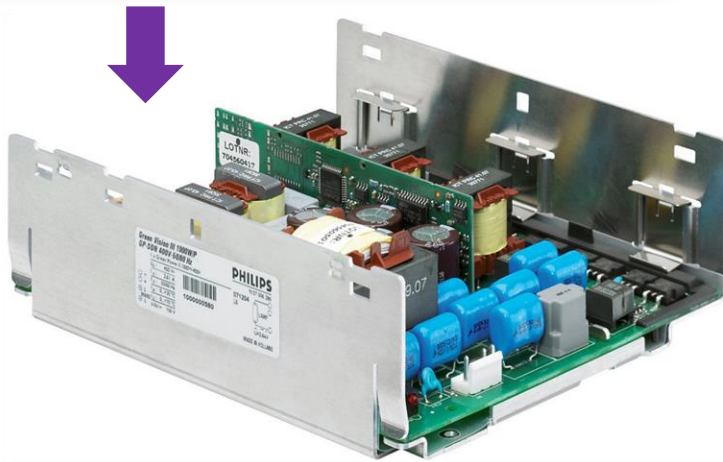

USAGE OF OUR PRODUCTS

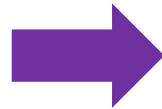
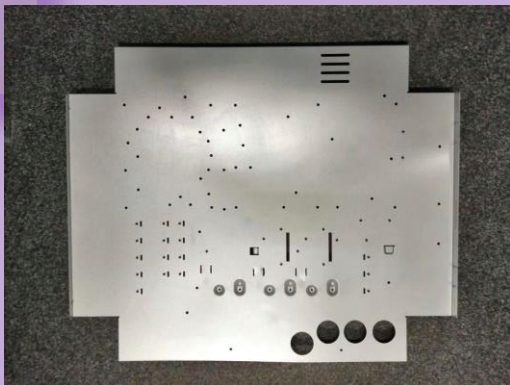

USAGE OF OUR PRODUCTS

Traffic lights components Swarco

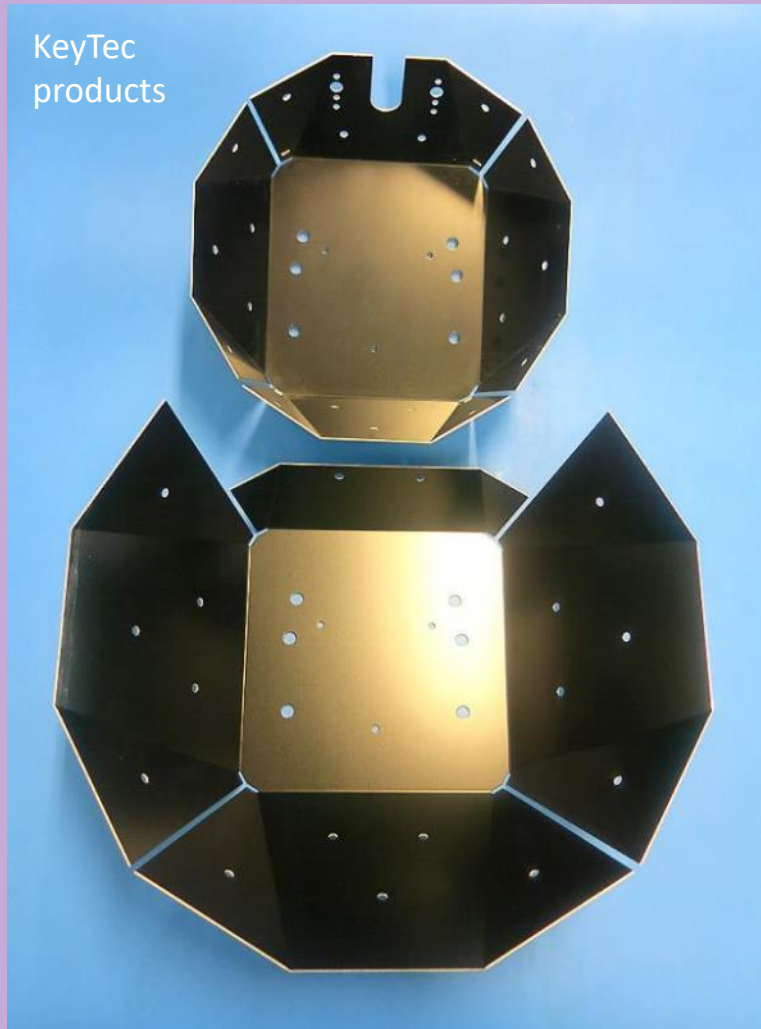

Contacts

Business Development Department:

- gerard.staes@keytec.cz
- marcel.vlk@keytec.cz
- josef.lastuvka@keytec.cz
- vojtech.svarc@keytec.cz
- jan.prachar@keytec.cz



KeyTec
PRECISION COMPONENTS





“We Industrialize Your Idea”

www.KeyTecGroup.com

